



Catálogo para perfiles de PVC

Roto Frank México
Tecnología en herrajes para puertas y ventanas

Roto Frank México

<https://rotomexico.com/>



Vamos más allá

A lo largo de toda nuestra cadena de valor, apostamos por la sostenibilidad social y ecológica. Al hacerlo, interactuamos constantemente con nuestros clientes y socios y, por lo tanto, desarrollamos soluciones de productos sostenibles en nuestros mercados.

Hoy.
Mañana.
Roto.



Índice

Información

Certificados	3
Denominación de cotas y mano del herraje	5

Ventanas NX

Oscilobatiente 1 hoja	7 - 8
Hoja pasiva con pasadores	9 - 10
Hoja pasiva con cremona 2° Hoja	11 - 12
Practicable 1 hoja cota variable	13 - 16
Hoja Abatible	17 - 18
Cremonas (OB/Easy mix), prolongadores	19 - 21
Herrajes opcionales	22
Break Stay Plantillas	23
Compases de proyección	24
Proyección	25 - 26
Cerraderos OB	27

Puertas

Cerraduras y sus componentes	28 - 31
Piezas opcionales y cerraderos	32 - 33

Corredizas

Herraje corrediza (ventana ag.7 y puerta ag.17)	34 - 37
Tiradores para corrediza, topes, cerraderos y ruedas	38 - 39

Aperturas especiales

Herraje para plegable	40 - 44
Herraje para Elevadora (Patio Lift)	45 - 46
Herraje para Osciloparalela (Patio Alversa)	47 - 48
Herraje para Paralela (Patio Alversa)	49 - 50

Información general

Denominación de cotas y mano del herraje

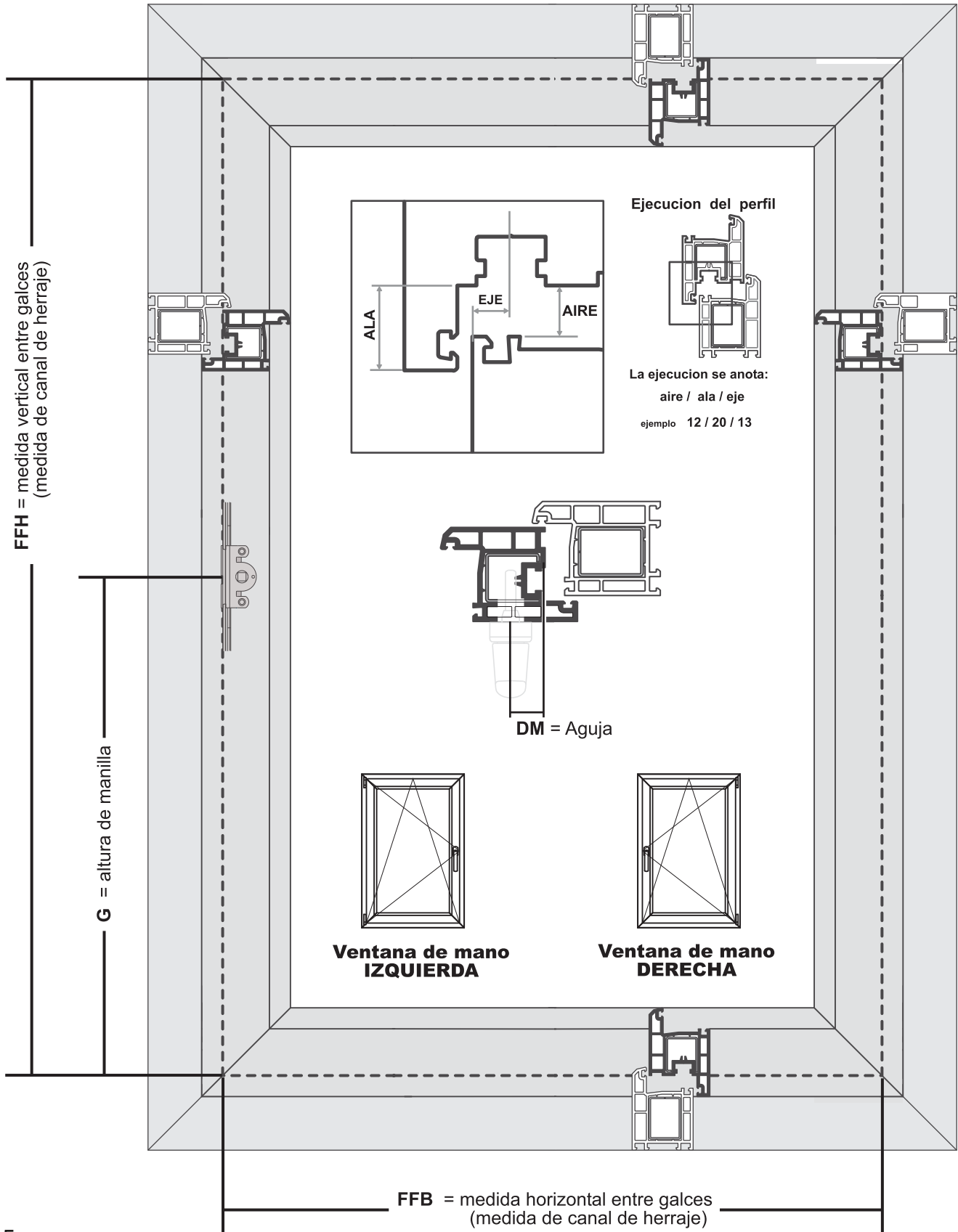



Ventanas

Descubre la precisión y durabilidad en cada detalle

Oscilobatiente 1 hoja NX

Presentación de herraje

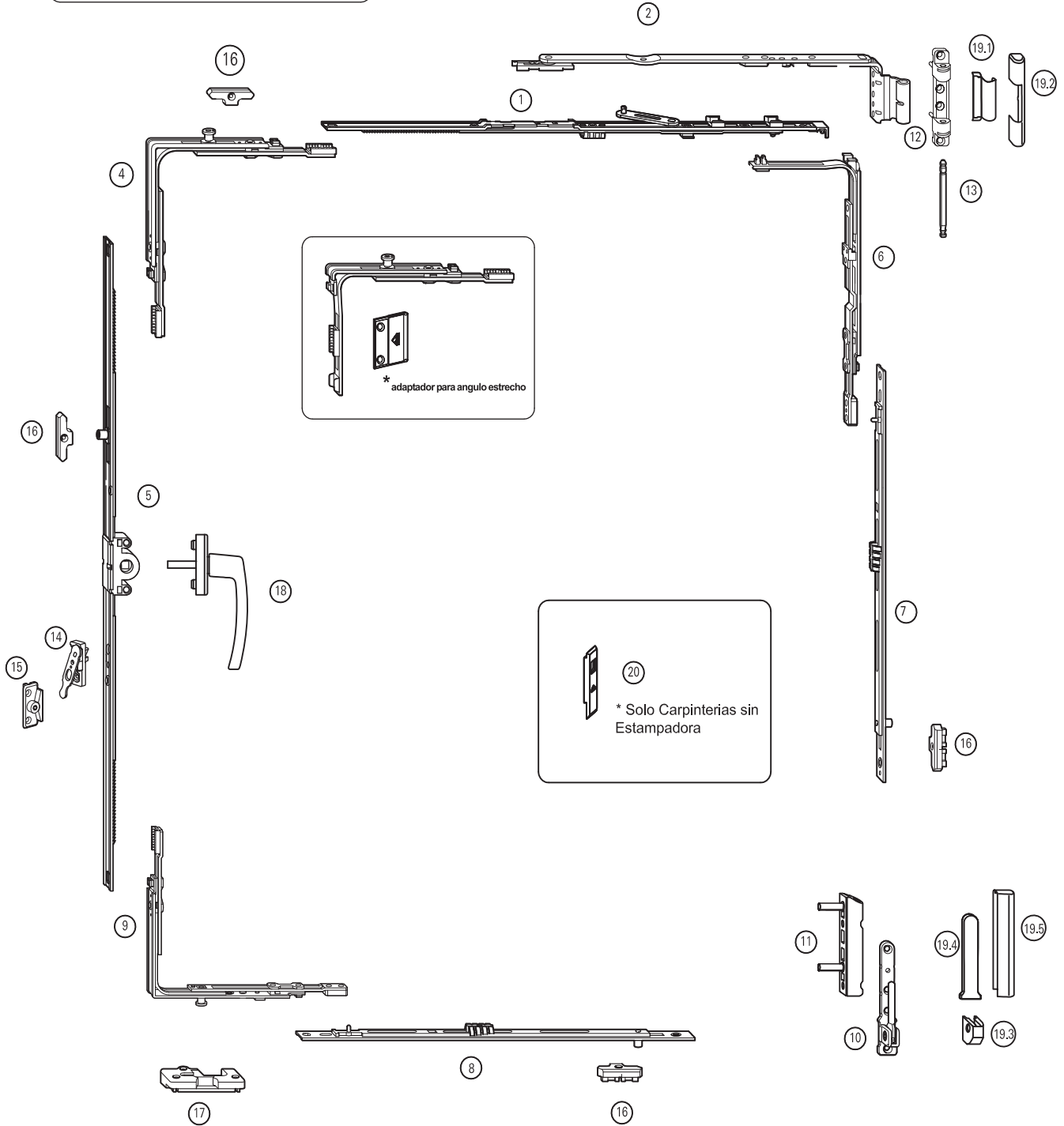
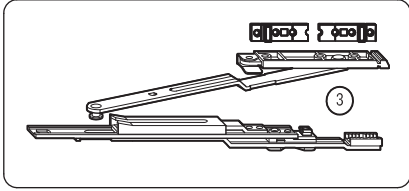

Oscilobatiente 1 hoja NX

Listado de herraje Cota Variable



	Rango (FFB)	Cantidad	Código				
01 Guía Compas	290-410	1	NT787345				
	411-600	1	NT787346				
	601-800	1	NT787347				
	801-1000	1	NT787360				
	1001-1200	1	NT787361				
	1201-1600	1	NT787362				
02 Compas	FFB			Izq 9mm	Der 9mm	Izq 13mm	Der 13mm
	290-410	1	NT787225	NT787226	NT787233	NT787234	
	411-600	1	NT787227	NT787228	NT787235	NT787236	
	601-800	1	NT787229	NT787230	NT787237	NT787238	
	801-1600	1	NT787231	NT787232	NT787239	NT787240	
	FFB						
03 Segundo Compas	1401-1600	1	NT255237 + Suplemento plastico (Ver página 27)				
04/09 Angulo estrecho Angulo estándar	FFH						
	310-450	2	NT281288 + NT255211				
05 Cremona CV Ag. 15	451-2400	2	NT260272				
	FFH						
	310-450	1	NT259717				
	451-620	1	NT259718				
	621-800	1	NT355743				
	801-1200	1	NT355744				
	1201-1600	1	NT355745				
	1601-2000	1	NT795390				
06 Cierre Central Base	2001-2400	1	NT795393				
	FFH						
07 Cierre Central (Lateral)	801-2400	1	NT260284				
	FFH						
	801-1200	1	NT337710				
	1201-1400	1	NT337711				
	1401-1800	1	NT337710 + NT337711				
08 Cierre Central (Inferior)	1801-2000	2	NT337711				
	2001-2400	1	NT337710 + 2 PZAS NT337711				
	FFB						
	801-1200	1	NT337710				
	1201-1400	1	NT337711				
10 Pernio Angular 6/130 11 Bisagra Angular 6/130 12 Soporte Compas 13 Eje Soporte Compas 14 Falsa Maniobra Hoja 15 Falsa Maniobra Marco	1401-1600	1	NT337710+NT337711				
	FFH						
	801-1200	1	NT787208				
	1201-1400	1	NT263858				
	1401-1800	1	NT859172				
16 Cerradero de Bulón	1801-2000	1	NT834705				
	2001-2400	1	NT795927				
	621-2400	1	Ver página 27				
	FFH						
	621-800	2	Ver página 27				
17 Cerradero Basculación	801-1200	3	Ver página 27				
	1201-1800	5	Ver página 27				
	1801-2400	7	Ver página 27				
	FFB						
	801-1400	3	Ver página 27				
18 Manilla cuadradillo largo 35mm	1401-1600	4	Ver página 27				
		1	Ver página 27				
		1	Ver página 27				
		1	Ver página 27				
		1	Ver página 27				
19 Embellecedores		1	Ver página 27				
	Compas	19.1	1	NT788410	NT788407	NT788404	NT821926
	Sop. Compas	19.2	1	NT861167	NT788383	NT788380	NT862558
	Pernio	19.3	1	NT788426	NT788423	NT788420	NT821924
	Base pernio	19.4	1	NT788418	NT788415	NT788412	NT821925
20 Pletina de conexión NX	Bisagra	19.5	1	NT788434	NT788431	NT788428	NT821923
		3	NT350401 *Solo carpinterias sin estampadora				

- Incluir 2 tornillos de la referencia HPTM5X50C por cada manilla si el color es: Negro o Plata

- El simbolo * en las referencias significa: bajo pedido o sujeto a consulta

Hoja Pasiva con Pasadores

Presentación de herraje

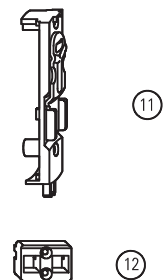
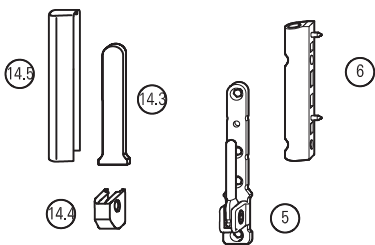
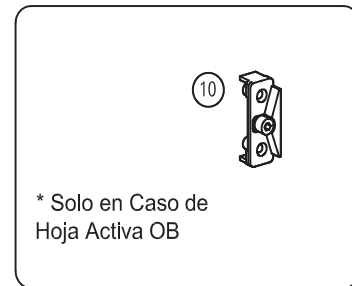
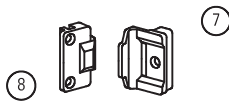
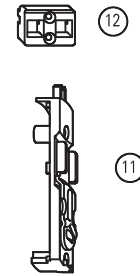
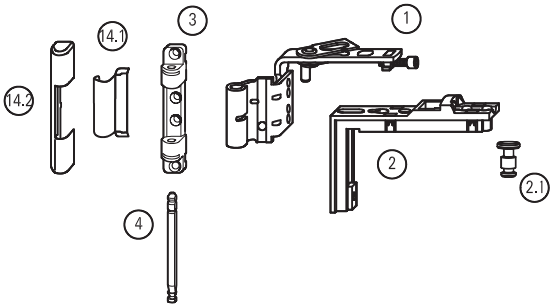
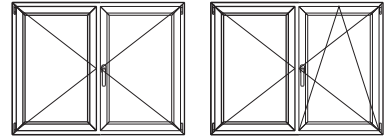

Hoja Pasiva con Pasadores NX

Listado de herraje



	Rango	Cantidad	Código	Izq 9mm	Der 9mm	Izq 13mm	Der 13mm
01 Falso Compas	290-410	1	NT787373	NT787374	NT787375	NT787376	
02 Base Falso Compas		1	NT331488				
02.1 Pieza union Falso Compas		1	NT230651				
03 Soporte Compas		1	NT859172				
04 Eje Soporte Compas		1	NT834705				
05 Pernio Angular 6/130		1	NT787208				
06 Bisagra Angular 6/130		1	NT263858				
FFH							
07 Cierre Oculto Hoja	801-1400	1	NT331485				
	1401-2000	2	NT331485				
	2001-2400	3	NT331485				
FFH							
08 Cierre Oculto Marco	801-1400	1	Ver Página 27				
	1401-2000	2	Ver Página 27				
	2001-2400	3	Ver Página 27				
10 Falsa Maniobra Batiente		1	NT260539				*Hoja Activa OsciloBatiente
11 Pasador Canal Herraje		2	NT305638				
12 Cerradero Pasador		2	Ver Página 27				
FFH							
13 Cerradero Canal 16	621-1200	1	NT260359				
	1201-2000	2	NT260359				
	2001-2400	4	NT260359				
14 Embellecedores	Compas	14.1	1	Blanco NT788410	Marron NT788407	Titan NT788404	Negro NT821926
	Sop. Compas	14.2	1	NT861167	NT788383	NT788380	NT862558
	Pernio	14.3	1	NT788426	NT788423	NT788420	NT821924
	Base pernio	14.4	1	NT788418	NT788415	NT788412	NT821925
	Bisagra	14.5	1	NT788434	NT788431	NT788428	NT821923

Hoja Pasiva con Cremona 2° Hoja

Presentación de herraje

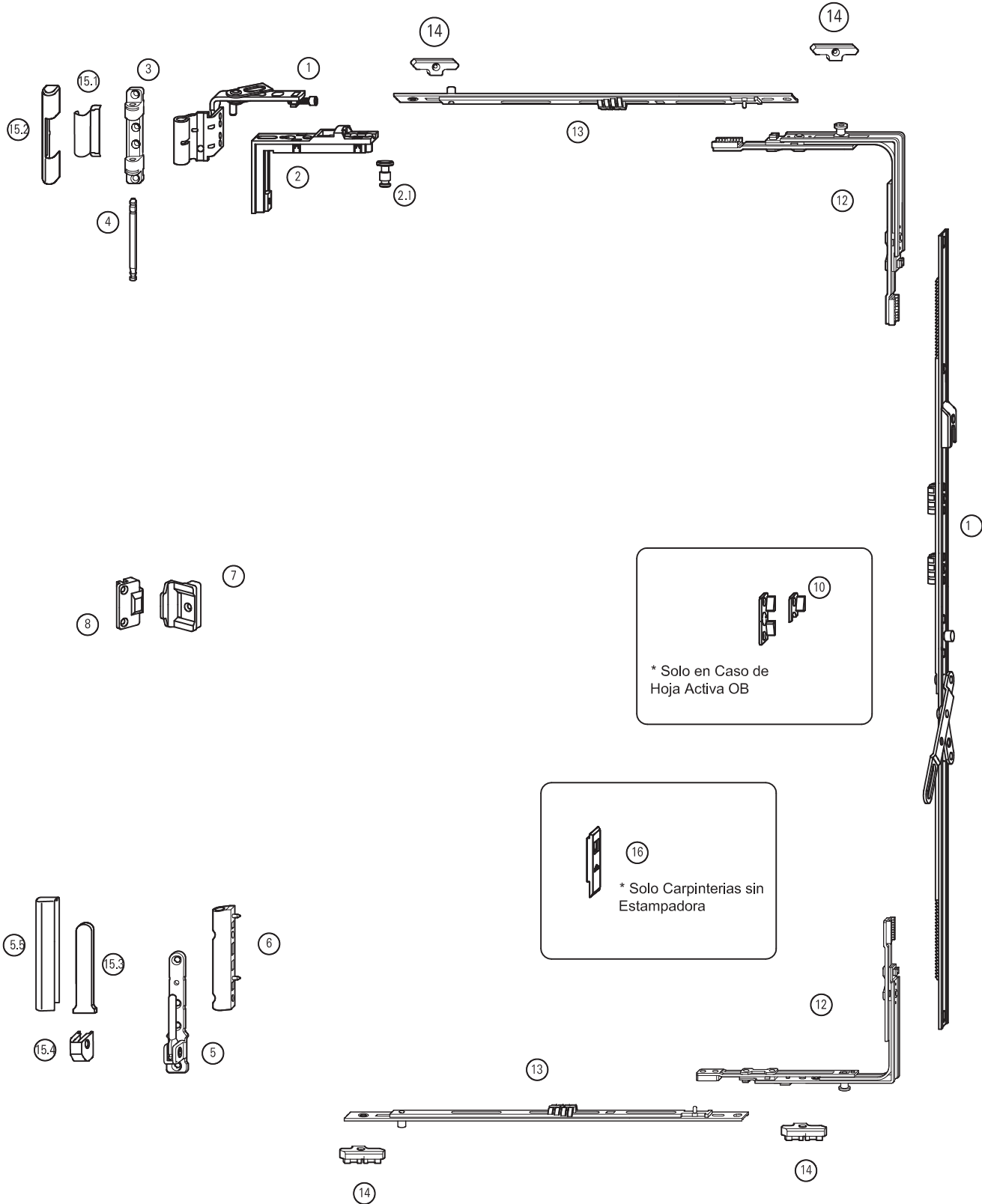
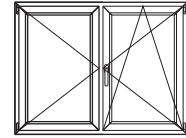

Hoja Pasiva con Cremona 2° Hoja

Listado de herraje



	Rango	Cantidad	Código				
			Izq 9mm	Der 9mm	Izq 13mm	Der 13mm	
01 Falso Compas		1	NT787373	NT787374	NT787375	NT787376	
02 Base Falso Compas		1	NT331488				
02.1 Unión Falso Compas		1	NT230651				
03 Soporte Compas		1	NT859172				
04 Eje Soporte Compas		1	NT834705				
05 Pernio Angular 6/130		1	NT787208				
06 Bisagra Angular 6/130		1	NT263858				
FFH							
07 Cierre Oculto Hoja	801-1400	1	NT331485				
	1401-2000	2	NT331485				
	2001-2400	3	NT331485				
FFH							
08 Cierre Oculto Marco	801-1400	1	Ver Página 27				
	1401-2000	2	Ver Página 27				
	2001-2400	3	Ver Página 27				
10 Falsa Maniobra Crem. 2° H	621-2400	1	NT257600			*Hoja Activa OsciloBatiente	
11 Cremona 2° hoja	FFH						
		431-620	1	NT233418			
	*Rango aplicable para cremonna de cota variable aguja 15, 25 30, 35 Y 40		621-800	1	NT763125		
			801-1200	1	NT763126		
			1201-1600	1	NT763127		
			1601-2000	1	NT795482		
		2001-2400	1	NT795484			
12 Angulo de cambio		2	NT260272				
13 Cierre central (inferior)	FFB						
		801-1200	2	NT337710			
		1201-1400	2	NT337711			
		1401-1600	2	NT337710 + NT337711			
14 Cerradero Bulon	FFB						
		0-800	2	Ver Página 27			
		801-1400	4	Ver Página 27			
		1401-1600	6	Ver Página 27			
15 Embellecedores				Blanco	Marron	Titan	Negro
	Compas	15.1	1	NT788410	NT788407	NT788404	NT821926
	Sop. Compas	15.2	1	NT861167	NT788383	NT788380	NT862558
	Pernio	15.3	1	NT788426	NT788423	NT788420	NT821924
	Base pernio	15.4	1	NT788418	NT788415	NT788412	NT821925
Bisagra	15.5	1	NT788434	NT788431	NT788428	NT821923	
16 Pletina Conexion NX	FFB						
		801-1600	*2	NT350401			*solo carpinterias sin Estampadoras

Practicable 1 Hoja Cota Variable

Presentación de herraje

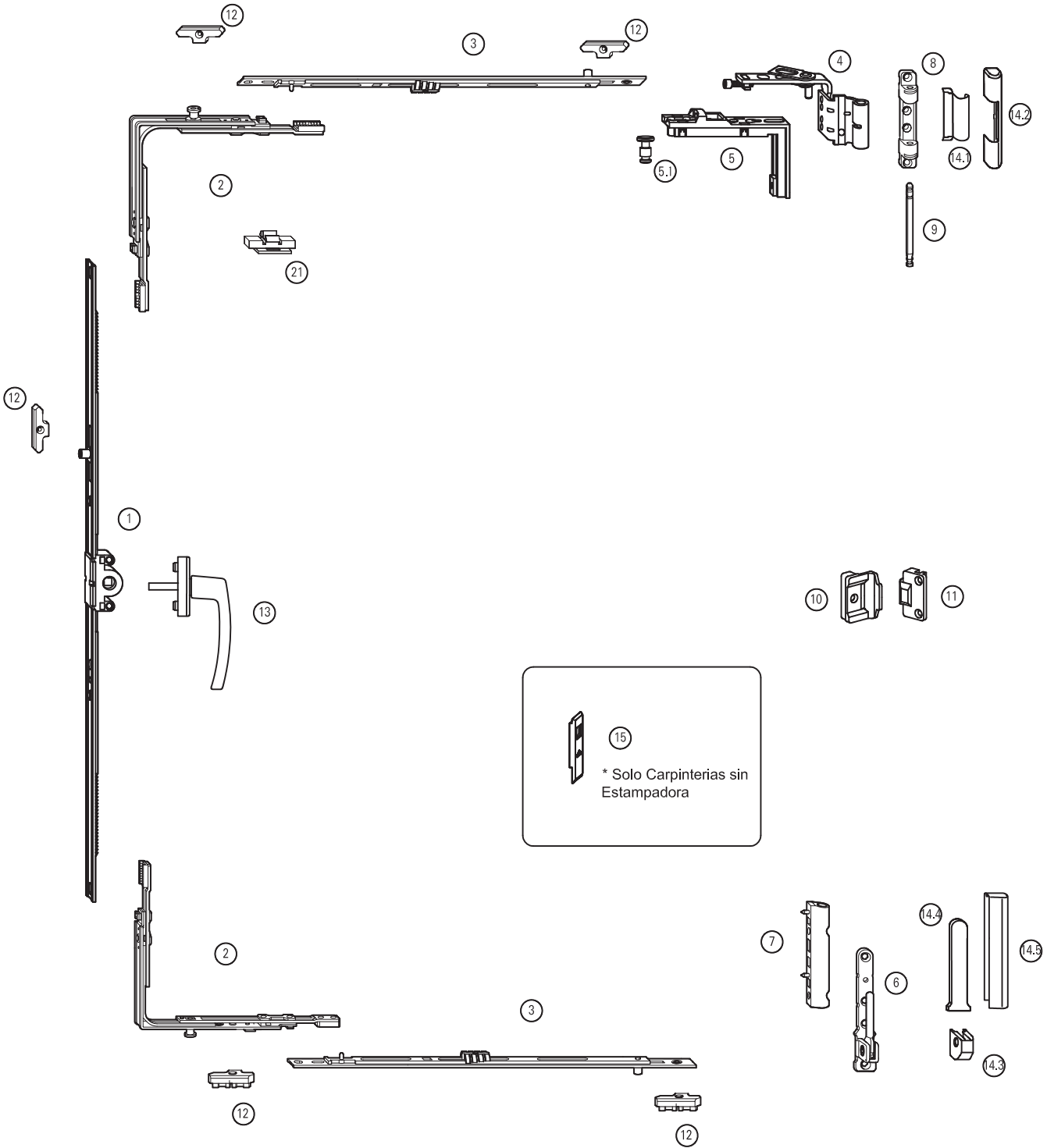
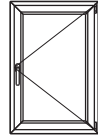

Practicable 1 Hoja Cota Variable

Listado de herraje

	Rango	Cantidad	Código				
01 Cremona CV aguja 15 mm	FFH						
	310-450	1	NT259717				
	451-620	1	NT259718				
	621-800	1	NT355743				
	801-1200	1	NT355744				
	1201-1600	1	NT355745				
	1601-2000	1	NT795390				
	2001-2400	1	NT795393				
02 Angulo de Cambio	FFH						
	310-450	1	NT281288 + NT255211				
	451-2400	1	NT260272				
03 Cierre Central (inferior)	FFB						
	801-1200	2	NT337710				
	1201-1400	2	NT337711				
	1401-1600	2	NT337710 + NT337711				
04 Falso Compas		1	Izq 9mm NT787373	Der 9mm NT787374	Izq 13mm NT787375	Der 13mm NT787376	
05 Base Falso Compas		1	NT331488				
05.1 Pieza union Falso Compas		1	NT230651				
06 Soporte Compas		1	NT859172				
07 Eje Soporte Compas		1	NT834705				
08 Pernio Angular 6/130		1	NT787208				
09 Bisagra Angular 6/130		1	NT263858				
10 Cierre Intermedio Oculito Hoja	FFH						
	801-1400	1	NT331485				
	1401-2000	2	NT331485				
	2001-2400	3	NT331485				
11 Cierre Intermedio Oculito Marco	FFH						
	801-1400	1	Ver Página 27				
	1401-2000	2	Ver Página 27				
	2001-2400	3	Ver Página 27				
12 Cerradero Bulon	FFH						
	621-800	1	Ver Página 27				
	801-1800	3	Ver Página 27				
	1801-2400	4	Ver Página 27				
	FFB						
	801-1400	4	Ver Página 27				
	1401-1600	6	Ver Página 27				
13 Manilla cuadradillo largo 35mm		1	Blanco NT2033352	Marron NT256230	Titan NT255369	Negro NT794254	
14 Embellecedores	Compas	14.1	1	NT788410	NT788407	NT788404	NT821926
	Sop. Compas	14.2	1	NT861167	NT788383	NT788380	NT862558
	Pernio	14.3	1	NT788426	NT788423	NT788420	NT821924
	Base pernio	14.4	1	NT788418	NT788415	NT788412	NT821925
	Bisagra	14.5	1	NT788434	NT788431	NT788428	NT821923
	Tornillos de manilla M5 x 40			HPTM5X50C			
Incluir un par por cada manilla DE COLOR NEGRO Y PLATA							
21 Limitador de Carrera		1	NT565965				
16 Pletina Conexion NX	FFB						
	801-1600	*2	NT350401	*solo carpinterias sin Estampadoras			

Practicable 1 Hoja Cota Variable

Presentación de herraje

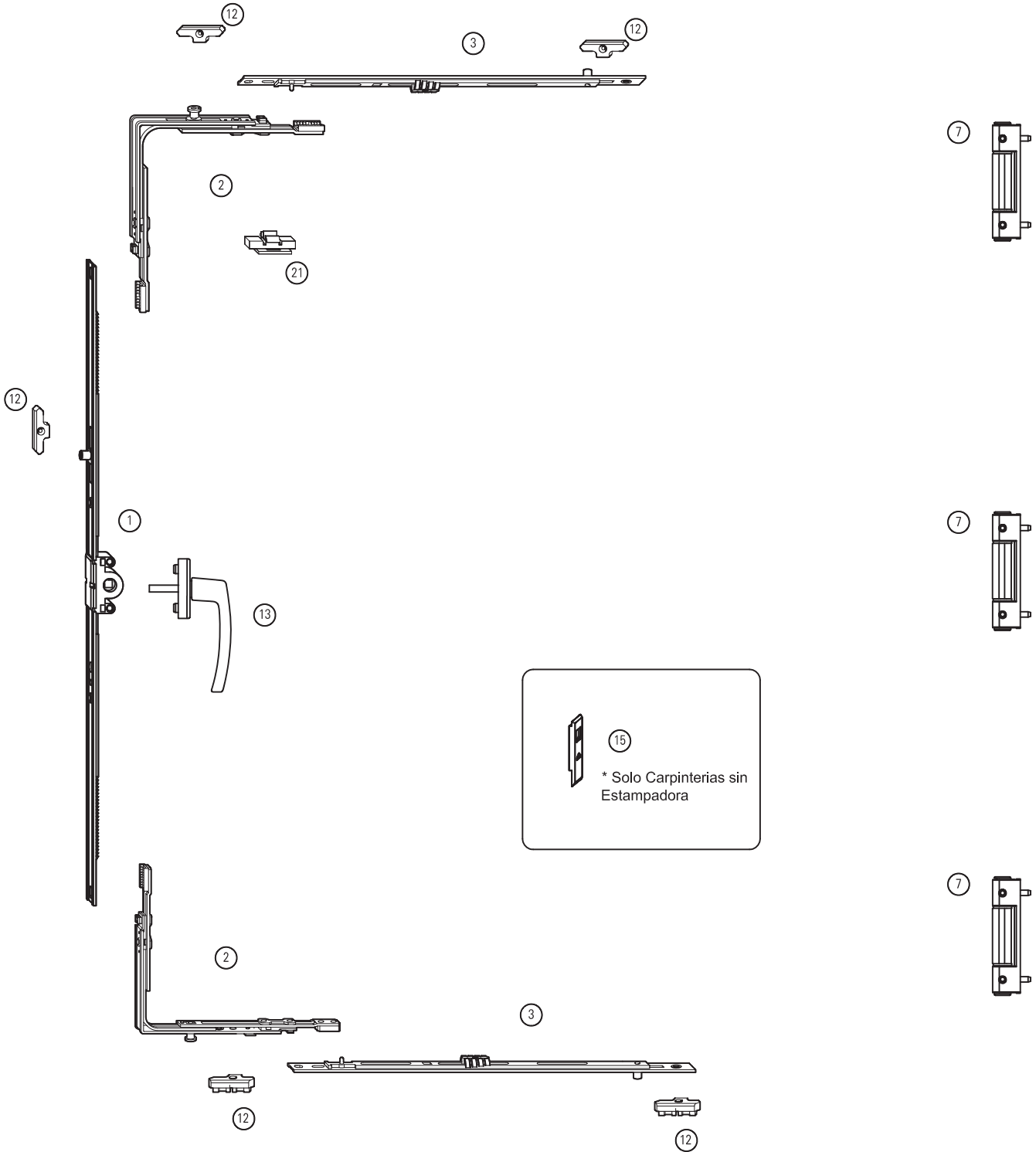
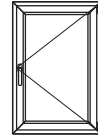

Practicable 1 Hoja Cota Variable

Listado de herraje

	Rango	Cantidad	Código				
01 Cremona CV aguja 15 mm	FFH						
	310-450	1	NT259717				
	451-620	1	NT259718				
	621-800	1	NT355743				
	801-1200	1	NT355744				
	1201-1600	1	NT355745				
	1601-2000	1	NT795390				
	2001-2400	1	NT795393				
02 Angulo de Cambio	FFH						
	310-450	1	NT281288 + NT255211				
	451-2400	1	NT260272				
03 Cierre Central (inferior)	FFB						
	801-1200	2	NT337710				
	1201-1400	2	NT337711				
	1401-1600	2	NT337710 + NT337711				
07 Bisagra 2D	Rango FFB						
	801-1000	2	Blanco	0°	NT242485		
	1001-1800	3	Blanco	0°	NT242485		
	1801-2400	4	Blanco	0°	NT242485		
	801-1000	2	Blanco	5°	NT242489		
	1001-1800	3	Blanco	5°	NT242489		
	1801-2400	4	Blanco	5°	NT242489		
	801-1000	2	Marrón	0°	NT355496		
	1001-1800	3	Marrón	0°	NT355496		
	1801-2400	4	Marrón	0°	NT355496		
	801-1000	2	Marrón	5°	NT355424		
	1001-1800	3	Marrón	5°	NT355424		
	1801-2400	4	Marrón	5°	NT355424		
	801-1000	2	Titán	0°	NT603147		
	1001-1800	3	Titán	0°	NT603147		
	1801-2400	4	Titán	0°	NT603147		
	801-1000	2	Titán	5°	NT791954		
	1001-1800	3	Titán	5°	NT791954		
	1801-2400	4	Titán	5°	NT791954		
	801-1000	2	Negro	5°	NT92005		
	1001-1800	3	Negro	5°	NT92005		
	1801-2400	4	Negro	5°	NT92005		
	12 Cerradero Bulón	FFH					
		621-800	1	Ver Página 27			
		801-1800	3	Ver Página 27			
		1801-2400	4	Ver Página 27			
		FFB					
801-1400	4	Ver Página 27					
1401-1600	6	Ver Página 27					
13 Manilla cuadradillo largo 35mm		1	Blanco NT2033352	Marron NT256230	Titan NT255369	Negro NT794254	
Tornillos de manilla M5 x 40 Incluir un par por cada manilla DE COLOR NEGRO Y PLATA			HPTM5X50C				
21 Limitador de Carrera		1	NT565965				
16 Pletina Conexion		*2	NT350401	*solo carpinterias sin Estampadoras			

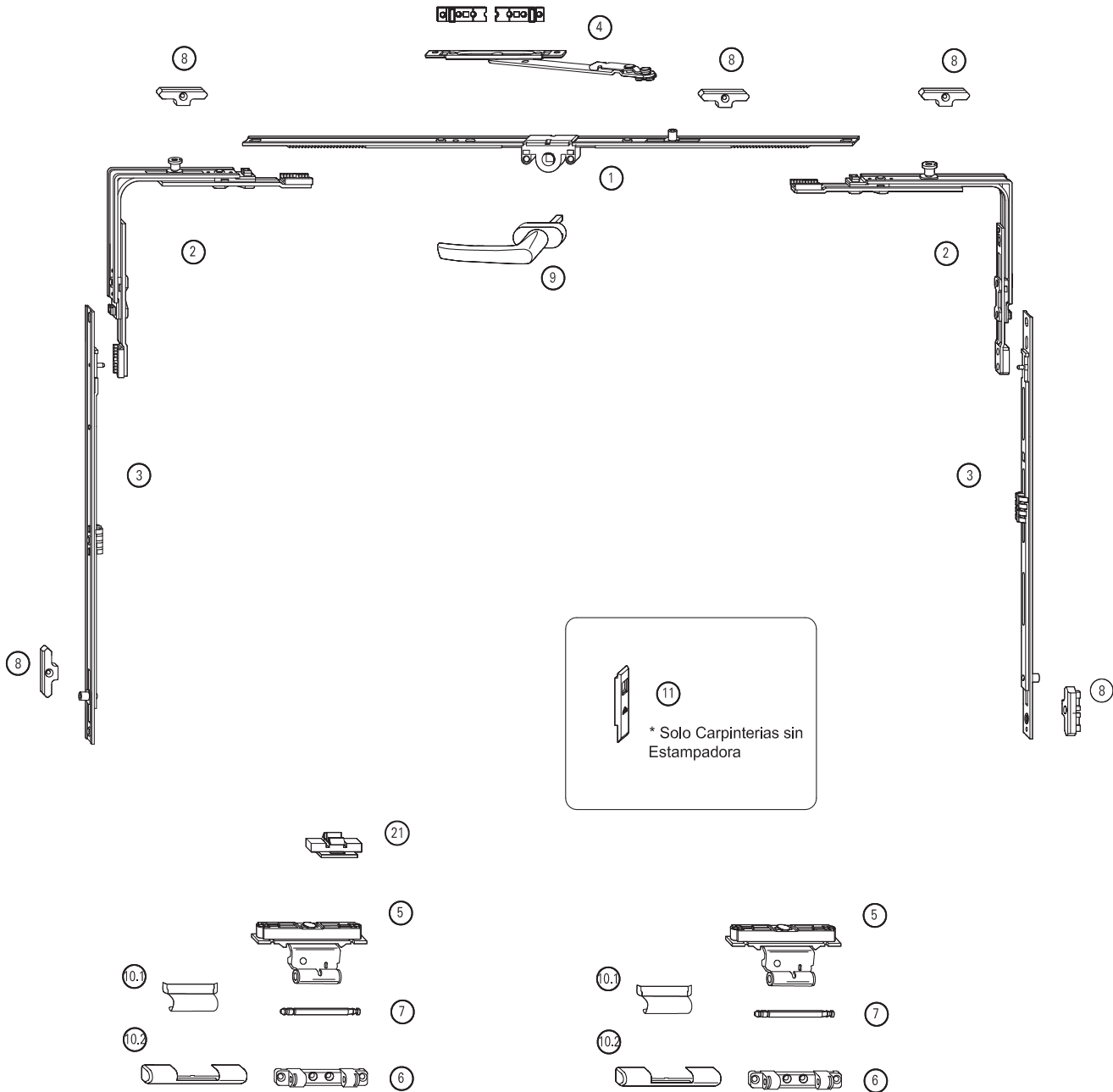
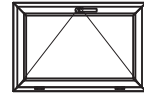

Hoja Abatible

Presentación de herraje



Hoja Abatible

Listado de herraje

	Rango	Cantidad	Código				
01 Cremona CV aguja 15 mm	FFB						
	310-450	1	NT259717				
	451-620	1	NT259718				
	621-800	1	NT355743				
	801-1200	1	NT355744				
	1201-1600	1	NT355745				
	1601-2000	1	NT795390				
	2001-2400	1	NT795393				
02 Angulo de Cambio		2	NT260272				
03 Cierre Central	FFH						
	801-1200	2	NT337710				
	1201-1400	2	NT337711				
	1401-1600	2	NT337710 + NT337711				
04 Compas Abatible	FFB						
	310-1000	1	NT482823 + *suplemento plastico. Ver página 27				
	1001-1800	2	NT482823 + *suplemento plastico. Ver página 27				
	1801-2400	3	NT482823 + *suplemento plastico. Ver página 27				
05 Bisagra Abatible Intermedia	FFB			12 / 20 / 9	12 / 20 / 13		
	310-1000	2	NT264007	NT787387			
	1001-1800	3	NT264007	NT787387			
	1801-2400	4	NT264007	NT787387			
06 Soporte Compas	FFB						
	310-1000	2	NT859172				
	1001-1800	3	NT859172				
	1801-2400	4	NT859172				
07 Eje Soporte Compas	FFB						
	310-1000	2	NT834705				
	1001-1800	3	NT834705				
	1801-2400	4	NT834705				
08 Cerradero Bulon	FFH						
	310-620	2	Ver Página 27				
	621-1200	3	Ver Página 27				
	1201-2000	4	Ver Página 27				
	FFB						
	801-1400	2	Ver Página 27				
	1401-1600	4	Ver Página 27				
09 Manilla cuadradillo largo 35mm				Blanco	Marron	Titan	Negro
			1	NT2033352	NT256230	NT255369	NT794254
				Blanco	Marron	Titan	Negro
				NT788434	NT788407	NT788404	NT821926
10 Embellecedores	Compas	10.1	1	NT861167	NT788383	NT788380	NT862558
	Sop. Compas	10.2	1				
Tornillos de manilla M5 x 40			HPTM5X50C				
Incluir un par por cada manilla DE COLOR NEGRO Y PLATA							
11 Pletina Conexion NX	FFB						
	801-1600	*2	NT350401	*solo carpinterias sin Estampadoras			
 							
Mariposa de compas abatible NT451432							
21 Limitador de Carrera		1	NT565965				

Cremonas Oscilobatientes Cota Variable con prolongacion y Cota Fija sin prolongación

EasyMix

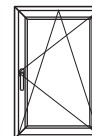

1 Cremona Oscilobatiente CV Aguja de 15 mm

FFH	B	G	
310-450		155-225	NT259717
451-620		226-310	NT259718
621-800	1	311-400	NT355743
801-1200	1	401-600	NT355744
1201-1600	2	601-800	NT355745
1601-2000	2	801-1000	NT795390
2001-2400	4	1001-1200	NT795393

3 Cremona Oscilobatiente CV Aguja de 25 mm Easy-Mix

FFH	B	G	Código
520-620		260-310	NT840759
621-800	1	311-400	NT788318
801-1200	1	401-600	NT788320
1201-1600	2	601-800	NT788322
1601-2000	2	801-1000	NT795365
2001-2400	4	1001-1200	NT795367

***Añadir Caja de Manilla para Aguja 25 mm

NT787675

3 Cremona Oscilobatiente CV Aguja de 30 mm Easy-Mix

FFH	B	G	Código
520-620		260-310	NT840759
621-800	1	311-400	NT788318
801-1200	1	401-600	NT788320
1201-1600	2	601-800	NT788322
1601-2000	2	801-1000	NT795365
2001-2400	4	1001-1200	NT795367

***Añadir Caja de Manilla para Aguja 30 mm

NT787677

3 Cremona CF Aguja de 25 mm Easy-Mix

FFH	B	G	Código
350-500	1	175-250	NT788328
501-800	2	251-400	NT788329
801-1100	3	401-550	NT788330
1101-1400	3	551-700	NT788331
1401-1800	4	701-900	NT788332
1801-2400	4	901-1200	NT788333

***Añadir Caja de Manilla para Aguja 25 mm

NT787675

3 Cremona CF Aguja de 30 mm Easy-Mix

FFH	B	G	Código
350-500	1	175-250	NT788328
501-800	2	251-400	NT788329
801-1100	3	401-550	NT788330
1101-1400	3	551-700	NT788331
1401-1800	4	701-900	NT788332
1801-2400	4	901-1200	NT788333

***Añadir Caja de Manilla para Aguja 30 mm

NT787677

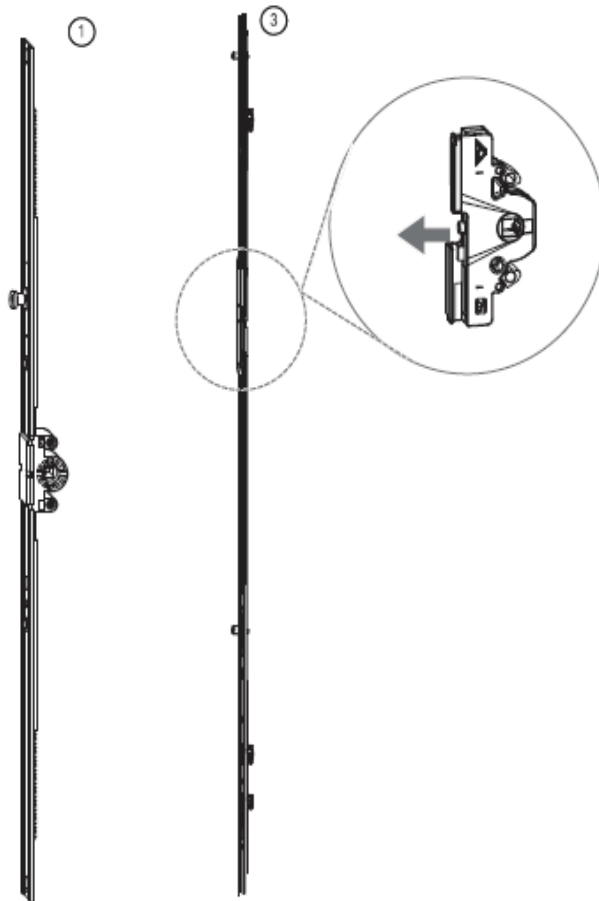

Cremonas Oscilobatientes con Llave y Manilla Ambos Lados

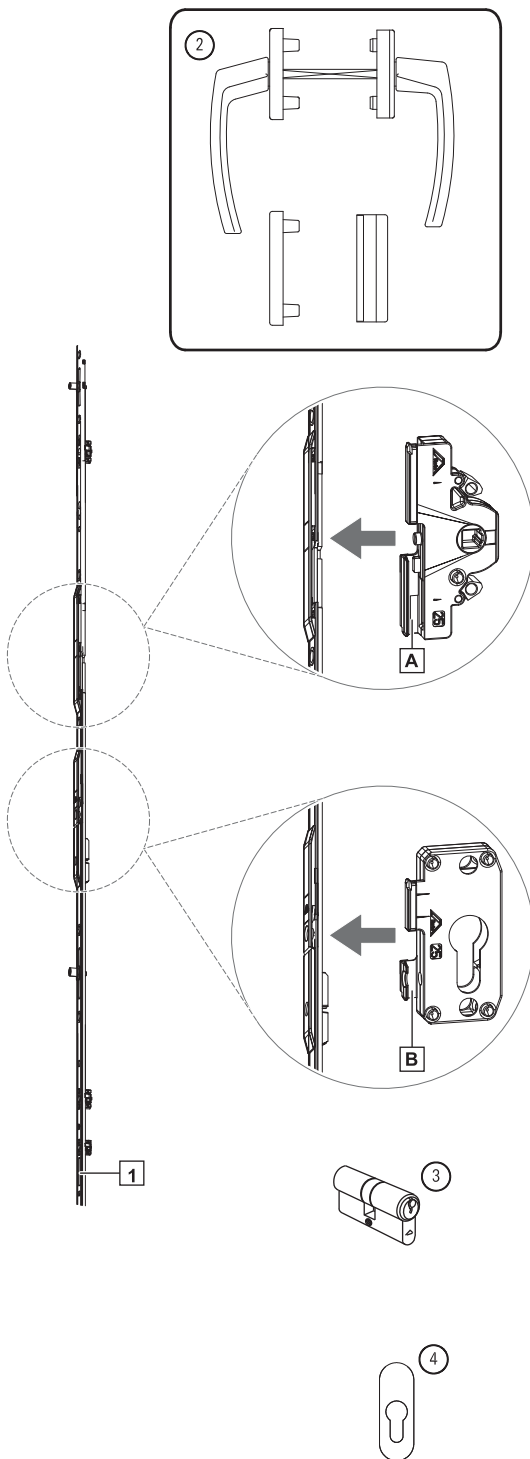

1 Cremona Oscilobatiente con Llave Aguja de 25 mm

FFH	B	G	Código
1601-2000	2	801-1000	NT795365
2001-2400	4	1001-1200	NT795367

***Añadir Caja de Manilla + Caja de cilindro

A Caja de Manilla para Cremona Easy-Mix

Aguja	Código
25mm	NT787675
30mm	NT787677

B Caja de Cilindro para Cremona Easy-Mix

Aguja	Código
25mm	NT787656
30mm	NT787658

2 Juego de Manillas con Roseta interior - exterior

Color	Código
Plata Natural R01.1	NT228380
Titan Mate R01.3	NT228333
Negro R06.2	NT794348
Marron R04.1	NT228335
Blanco R07.1	NT228336
Bronce R05.3	NT228383

3 Cilindro

Medida	Tipo	Código
40/40	Niquel	NT632590
45/45	Niquel	NT632594
45/50	Niquel	NT632605
40/40 Pomo	Niquel	NT775098
50/50	Niquel	NT349614
Llave virgen		NT349755

4 Roseta *Bocallave (accesorio)

Color	Código
Blanco	NT457375
Marron	NT457376
Titan	NT483671

Prolongadores Sistema NX

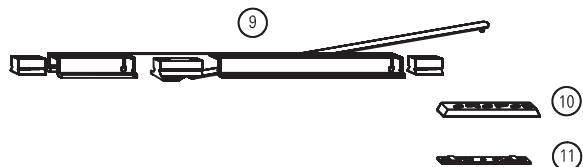
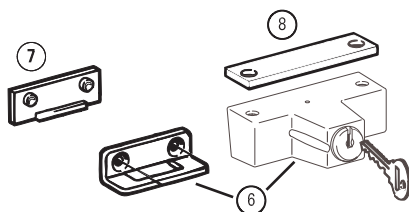
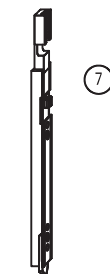
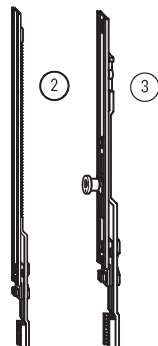

Código

1 Prolongador 600 con Bulon NT337711

1 Prolongador 400 con Bulon NT337710

2 Prolongador de Cremona 330 sin Bulon NT489993

2 Prolongador 200 sin Bulon NT308267

3 Prolongador 200 con Bulon NT337708

6 Prolongador Salida de Barra 11mm sin INVERSION NT457626

7 Prolongador Inversor 18 mm con INVERSION NT312033

6 Seguro Contra Apertura Practicable c/llave

Color		
Marron	R04.4	NT230152
Blanco	R07.2	NT230153

7 Suplemento Hoja

Color		
Marron	R04.4	NT230158
Blanco	R07.2	NT230155

8 Suplemento Marco

Color		
Marron	R04.4	NT230159
Blanco	R07.2	NT230156

9 Compas Limitador

Modelo		
191		NT260564
335		NT260565

10 Soporte Compas Limitador

Código
NT264625

11 Soporte Compas Limitador

Ver Página 27

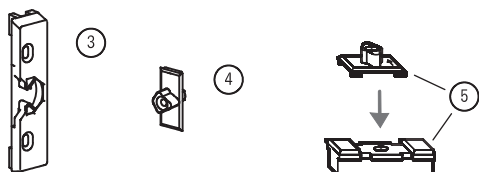

3 Clic Retenedor a Marco

Ver Página 27

4 Chapa Clic Retenedor sobre cremona

Código

NT256020

5 Retenedor sobre Canal

Código

Aluplast

NT788363 + NT788572

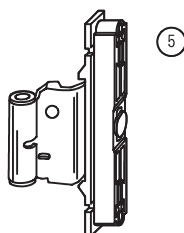

5 Bisagra Intermedia / Abatible

Cotas	Código
12 / 20 / 9	NT264007
12 / 20 / 13	NT787387

6 Bisagra Practicable 2D 85 mm

Color	Inclinación	Código
Marron R04.1	0°	NT355496
	5°	NT355424
Blanco R07.2	0°	NT242485
	5°	NT242489
Titan R01.5	0°	NT603147
	5°	NT791954
Negro R06.2	0°	
	5°	NT792005

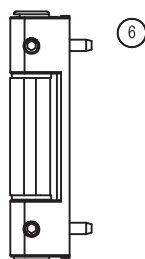

6 Bisagra Practicable 2D 75 mm

Color	Inclinación	Código
Marron R04.1	0°	NT772294
Blanco R07.2	0°	NT772325

Plantilla Bisagra Practicable 2D 75 mm

Código

NT776864

Breakstay | Plantillas Sistema NX



(A)



(B)

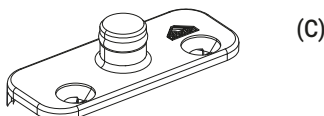

(C)

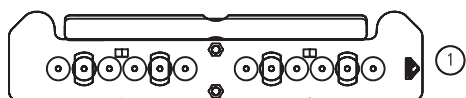

1

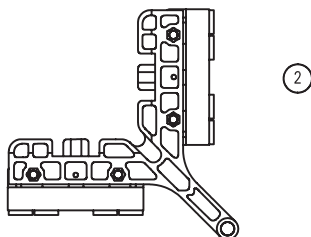

2

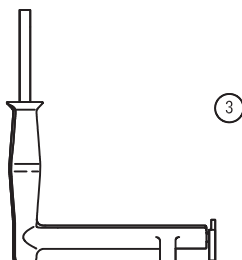

3

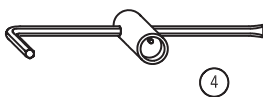

4



5

(A) Compas de fijacion - Breakstay

Cantidad	Rango	Código
1	480 - 1560	NT486820

(B) Brazo

Aplicación a:	Cantidad	Rango	Código
Angulo estrecho	1	480 - 560	NT486821
Angulo estandar	1	561 - 1560	NT492757

(C) Pieza Marco

Cantidad	Código	
Todas las marcas	1	NT477848
Eurofine	1	NT477849

1 Plantilla Soporte y Pernio

Diametro	Código
6mm	NT788436

*Aplicable para aletas de 18, 20, 22 mm

2 Plantilla Bisagra Angular

Diametro	Código
6mm	NT788488

*Aplicable para ejes de 9 y 13 mm

3 Manilla y Extractor Eje Bisagra

Código
NT899630

Llave de regulación diseño

Código
NT381574

4 Llave Regulacion Bulon Seguridad

Código
NT258191

5 Llave Regulacion 4 mm

Código
NT208609

Compases Proyectantes Defender y Storm, Accesorios

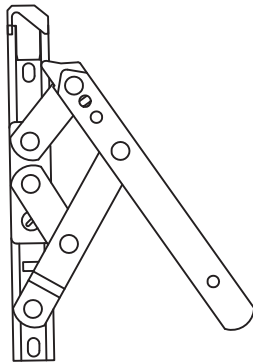

1 Compas Defender Ferritico (Acero 403)

FFH	Cam	Medida	Kgs	Código
200-275	13	8"	12	NT318423
276-400	13	10"	16	NT318424
401-550	13	12"	20	NT318425
551-750	13	16"	21	NT318426
751-1000	13	20"	24	NT318427
1001-1200	13	24"	35	NT318428

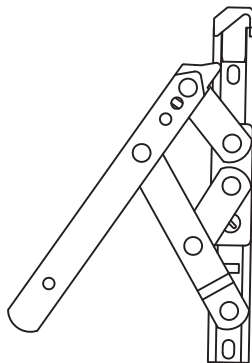

1 Compas Defender Ferritico (Acero 304) TOP-HUNG

FFH	Cam	Medida	Kgs	Código
300-450	16	8"	35	NT785740
300-650	16	10"	35	NT823192
450-800	16	12"	45	NT823193
600-950	16	14"	50	NT823194
750-1250	16	16"	65	NT823195
1100-1500	16	22"	100	NT823196
1200-1800	16	24"	120	NT823197
1450-2500	16	26"	180	NT823198

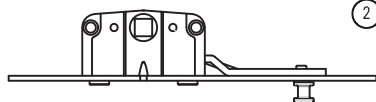

2 Cremona Proyectante Aguja de 20mm

FFB	Bulones	Medida	Código
200-400	1	200	NT641987
401-600	2	400	NT641988
601-800	2	600	NT641989
800-1000	2	800	NT641990
1000-1200	3	1000	NT641991
12000-1400	3	1200	NT641992



2.1 Cremona Aguja 22mm

FFB	Bulones	Medida	Código
200-400	1	800	NT611959

3 Manilla Estrecha sencilla

Color	Código
Blanco	NT280995
Negro C/LL	NT5711142

3 Manilla Estrecha con llave

Color	Código
Negro	NT614277

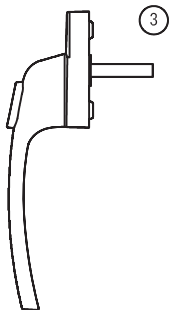

Cerradero para hojas diferente eje 13

Código
NT623115

*Artículo sobre pedido, consulte disponibilidad

Proyección

Listado de herraje

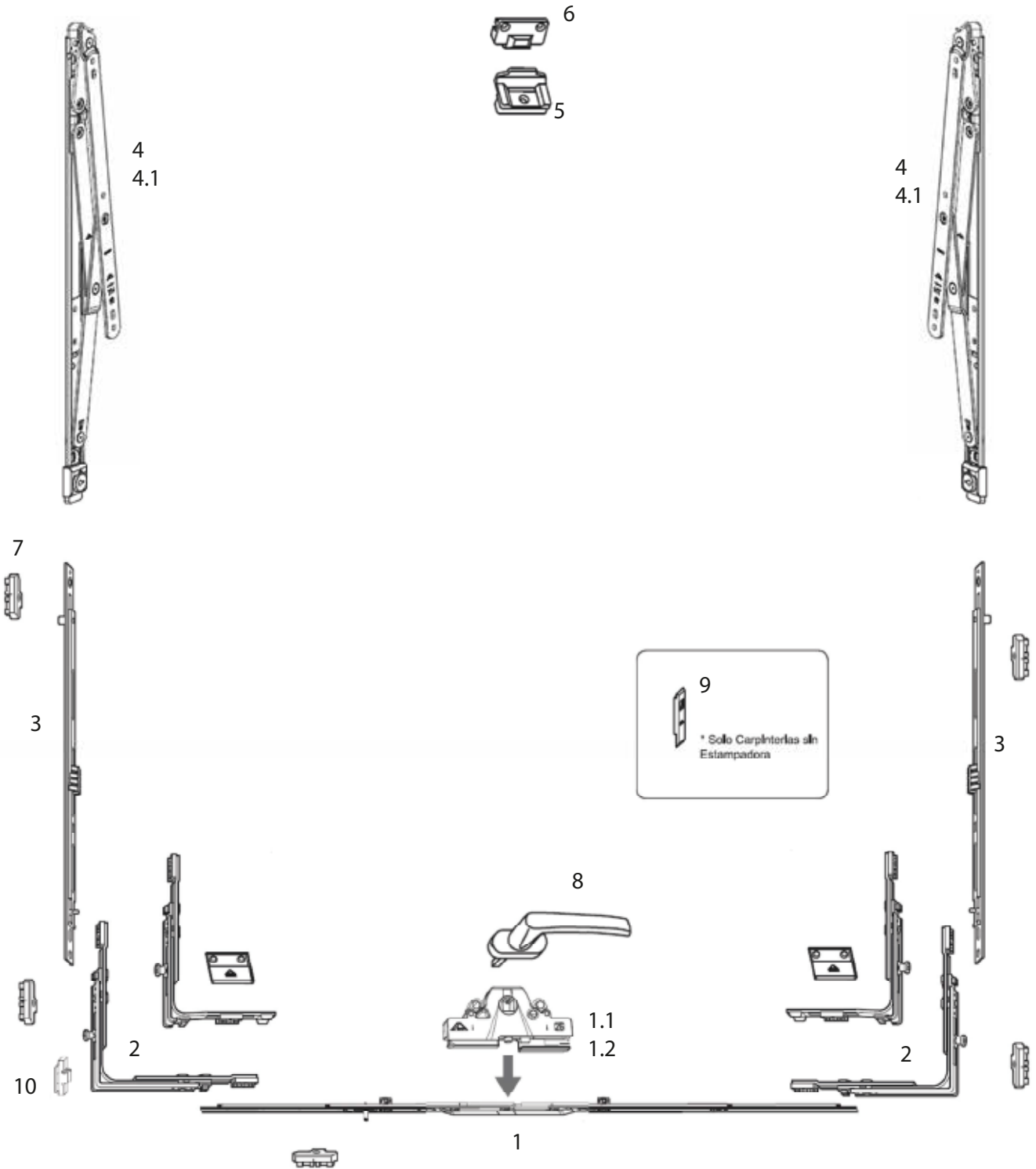

Proyección

Listado de herraje

	Rango	Cantidad	N. Bulón	Código	Alt. Manilla
01 Cremona CV aguja 25 y 30mm					
	430-920	1	-	NT840759	215-460
Seguridad básica	621-800	1	1E	NT788318	311-400
(Bulón cilíndrico)	801-1200	1	1E	NT788320	401-600
	1201-1600	1	2E	NT788322	601-800
	430-900	1	-	NT840759	215-460
Seguridad RC2	621-800	1	1V	NT833746	311-400
(Bulón champiñón)	801-1200	1	1V	NT833747	401-600
	1201-1600	1	2V	NT833748	601-800
	1601-2000	1	2V	NT795390	801-1000
	2001-2400	1	4V	NT795393	1001-1200
01.1 Caja de manilla Ag.25	430-2400	1		NT787675	
01.2 Caja de manilla Ag. 30	430-2400	1		NT787677	
	FFB				
2 Angulo de cambio	350-450	1		NT281288	+ NT255211
	451-2400	1		NT260272	
	FFB				
03 Cierre Central (Inferior)	801-1200	1		NT337710	
	1201-1400	1		NT337711	
	1401-1600	1		NT337710	+ NT337711
	FFH	Cantidad	Medida	Código	Kgs
04 Compas Cam. 13mm	200-350	1	8"	NT318423	12
	276-400	1	10"	NT318424	16
	351-500	1	12"	NT318425	20
	501-780	1	16"	NT318426	21
	701-1100	1	20"	NT318427	26
	1101-1300	1	24"	NT318428	40
04.1 Compas Cam. 16mm	300-450	1	8"	NT785740	35
	300-650	1	10"	NT823192	35
	450-800	1	12"	NT823193	45
	600-950	1	14"	NT823194	50
	750-1250	1	16"	NT823195	65
	1100-1500	1	22"	NT823196	100
	1200-1800	1	24"	NT823197	120
	1450-2500	1	26"	NT823198	180
05 Cierre intermedio oculto hoja	FFH				
	801-1400	1		NT331485	
	1401-2000	2		NT331485	
	2001-2400	3		NT331485	
06 Cierre inter. oculto marco	FFH				
	801-1400	1		Ver Página 27	
	1401-2000	2		Ver Página 27	
	2001-2400	3		Ver Página 27	
07 Cerradero de bulón	FFB				
	601-800	1		Ver Página 27	
	801-1800	3		Ver Página 27	
	1801-2400	4		Ver Página 27	
	FFB				
	801-1400	4		Ver Página 27	
	1401-1600	6		Ver Página 27	
08 Manilla cuadradillo largo 35mm		1		Blanco NT2033352	Marron NT256230
				Titan NT255369	Negro NT794254
	Tornillo de manilla M5X50	Incluir un para por cada manilla de color negro y plata.			
09 Pletina Conexión NX	801-1600	*2	NT350401	*solo carpinterías sin Estampadoras	
10 Limitador de carrera		1	NT565965		

Cerraderos OB

Perfil	Ranura /Ala	Cerradero de Bulon	Falsa Man. en Marco	Cierre Oculito en Marco	Suplemento Plastico	Cerr. Basc. Derecho	Cerr. Basc. Izquierdo	Cerradero Pasador
Aluplast 2000	13 / 20	NT331489	NT260551	NT264236	NT294364	NT331487	NT331487	NT260439
Aluplast 4000	13 / 20	NT350192	NT260557	NT257351	NT294365	NT350190	NT350190	NT257360
Deceunink Everetmax/Legend	13 / 20	NT370071	NT370175	NT370176	NT294469	NT370074	NT370073	NT370177
Kommerling Eurodur	13 / 20	NT260365	NT260545	NT250726	NT294464	NT260490	NT260489	NT260433
Kommerling Eurofutur	13 / 20	NT334957	NT264523	NT334961	NT294464	NT334954	NT334954	NT260433
Kommerling 76 / Profine eurofine Kbe70	13 / 20	NT738470	NT260554	NT264249	NT294370	NT780788	NT780787	NT286640
Rehau 4500	13 / 20	NT332439	NT260546	NT264236	NT294469	NT338021	NT338021	NT260434
Tecnoperfiles Newen/Efficient	13 / 20	NT332438	NT260552	NT250729	NT294364	NT349135	NT349134	NT263783
Veka 58	13 / 20	NT332438	NT260552	NT250728	NT294364	NT451237	NT451237	NT263783
Cortizo A70	13 / 20	NT738470	-	-	-	-	-	-
Tecnocom	9 / 20	NT260368	NT260548	NT250729	NT294537	NT260496	NT260495	NT260495
Veka Ekoline	9 / 20	NT260368	NT260548	NT250729	NT294537	NT260496	NT260495	NT260495

Perfil	Ranura /Ala	Cerradero de Seguridad	Cerradero Pasador	Clic Marco
Aluplast 2000	13 / 20	NT331490	NT260439	NT258939
Aluplast 4000	13 / 20	NT350191	-	-
Deceunink Everetmax/Legend	13 / 20	NT370072	NT370073	NT264391
Kommerling Eurodur	13 / 20	NT258303	NT260433	NT264391
Kommerling Eurofutur	13 / 20	NT334958	NT260433	NT334959
Kommerling 76 / Profine eurofine	13 / 20	NT738471	NT286640	NT334959
Rehau 4500	13 / 20	NT738471	NT286640	NT788615
Tecnoperfiles Newen/Efficient	13 / 20	NT316942	NT260434	NT260464
Veka 58	13 / 20	NT348410	NT263783	NT256781
Tecnocom	13 / 20	NT348410	NT263783	NT256781
Veka Ekoline	9 / 20	NT260392	NT260436	NT256782
	9 / 20	NT260392	NT260436	NT256782

13 / 20

Cerradura H650 para Puerta Operada por manilla

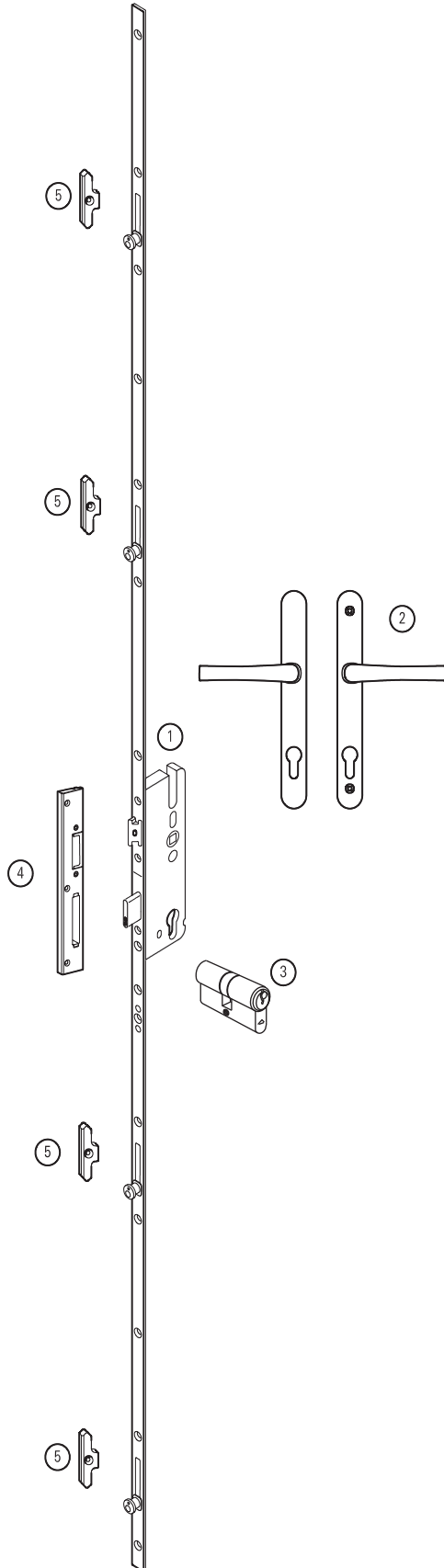
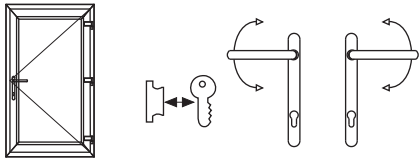

Solera

Descripción

Solera 62 mm Tramo 1.18mm
Solera 70 mm Barra 6 mm

Código

NT549282
NT549049

1 Cerradura H650 FFH 1900-2800 4 Bulones

Aguja	G	Sin prolongación	Prol. Sup.	Prol. Sup. e Inf.
25	1020	NT449872	NT2003442	NT2003447
28	1020		NT2003443	NT2003448
30	1020	NT553882		
35	1020	NT493029*	NT2003444	NT2003449

2 Manilla + Manilla (Manilla de Placa Larga)

Color

Blanco
Marron
Titan
Negro

Código

NT319954
NT340317
NT333215
NT319955

3 Cilindro

Medida

40/40
45/45
45/50
40/40 Pomo
50/50
40/60

Tipo

Niquel
Niquel
Niquel
Niquel
Niquel
Seguridad

Código

NT632590
NT632594
NT632605
NT775098
NT349614
NT640081

4 Cerradero Central

Ver Página 33

5 Cerradero de Bulon

Ver Página 33

6 Bisagra Puerta, PS23 14-17.5/ 85-31 hasta 80 kg

Color

Blanco
Marron
Plata
Negro

Código

NT492520
NT492519
NT493275
NT782925

6 Bisagra Puerta, PS27 14-17.5/ 105-39 hasta 120 kg

Color

Blanco
Marron
Plata
Negro

Código

NT492575
NT492574
NT2028262
NT784711

*CONSULTAR DISPONIBILIDAD/BAJO PEDIDO

Cerradura C600 | C240 Para Puerta Operada por Cilindro

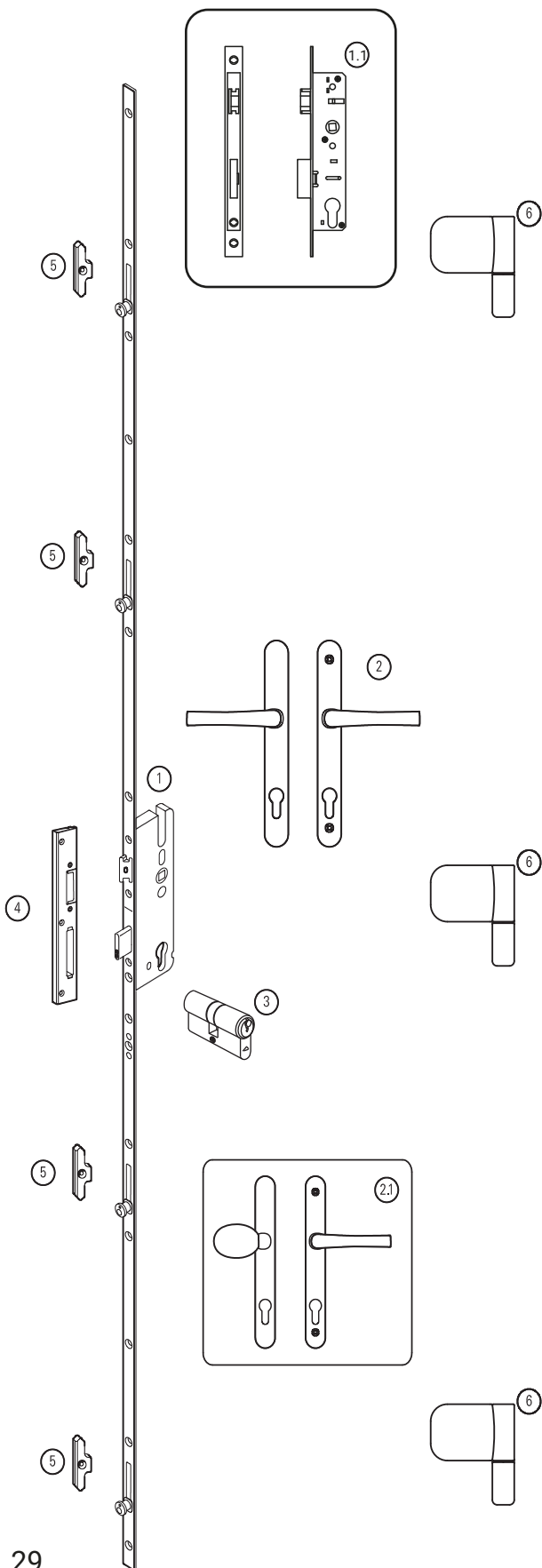
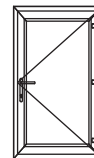

1 Cerradura C600

FFH	Aguja	B	G	Código
1900-2200	30	4	1020	NT611402
1900-2200	35	4	1020	NT776505
1900-2200	40	4	1020	NT776511

1.1 Cerradura corta C240*

FFH	Aguja	G	Código
1900-2200	25	1020	NT449872
1900-2200	30	1020	NT451239
1900-2200	35	1020	NT449873

2 Manilla + Manilla (Manilla de Placa Larga)

Color	Código
Blanco	NT319954
Marron	NT340317
Titan	NT333215
Negro	NT319955

2.1 Manilla + Tirador, solo con cerraduras operadas via cilindro

Color	Código
Blanco	NT340484
Marron	NT340322
Titan	NT340486
Negro	NT340485

3 Cilindro

Medida	Tipo	Código
40/40-	Niquel	NT632590
45/45	Niquel	NT632594
45/50	Niquel	NT632605
40/40 Pomo	Niquel	NT775098
50/50	Niquel	NT349614
40/60	Seguridad	NT640081

4 Cerradero Central Ver Página 33

5 Cerradero de Bulon Ver Página 33

6 Bisagra Puerta, PS23 14-17.5/ 85-31 hasta 80 kg

Color	Código
Blanco	NT492520
Marron	NT492519
Plata	NT493275
Negro	NT782925

6 Bisagra Puerta, PS27 14-17.5/ 105-39 hasta 120 kg

Color	Código
Blanco	NT492575
Marron	NT492574
Plata	NT2028262
Negro	NT784711

*La cerradura corta C240 no hace uso del punto 5.

Puerta Calle C600 Operada por Cilindro

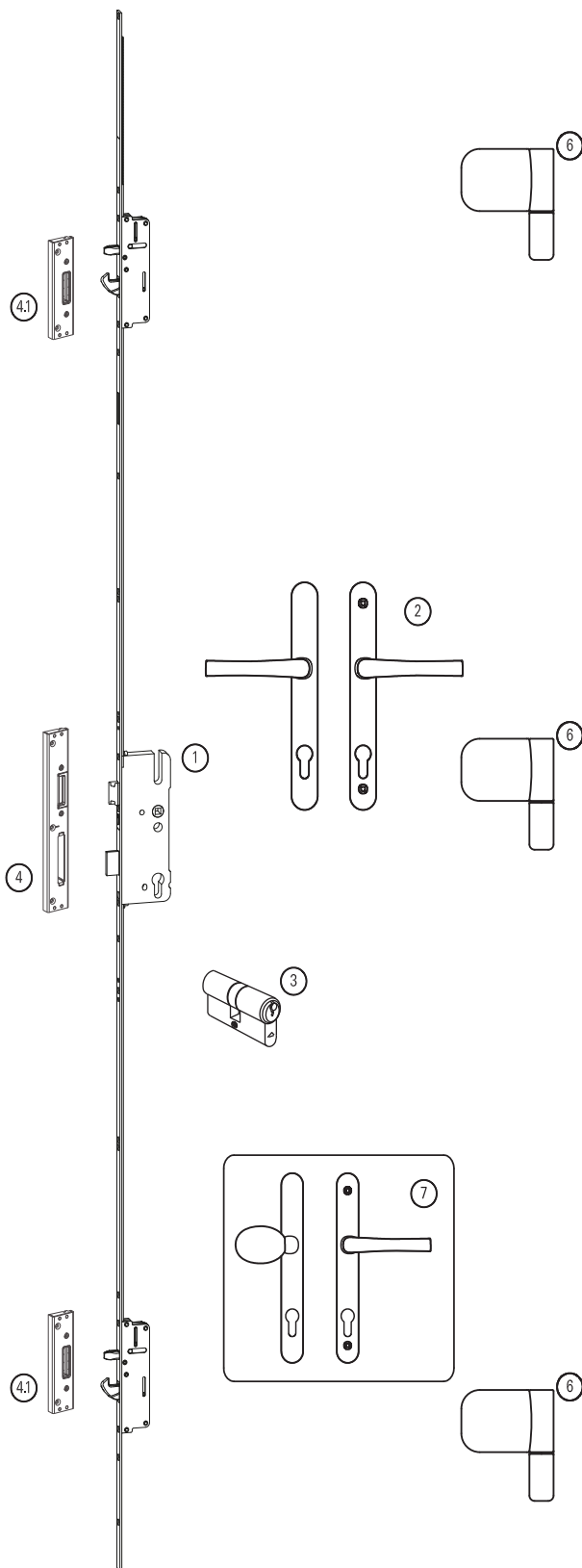
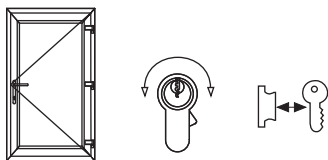

1 Cerradura C600

FFH	Aguja	B	G	Código
1900-2300	35	2	1020	NT776761

2 Manilla + Manilla (Manilla de Placa Larga)

Color	Código
Blanco	NT319954
Marron	NT340317
Titan	NT333215
Negro	NT319955

2.1 Manilla + Tirador, solo con cerraduras operadas via cilindro

Color	Código
Blanco	NT340484
Marron	NT340322
Titan	NT340486
Negro	NT340485

3 Cilindro

Medida	Tipo	Código
40/40	Niquel	NT632590
45/45	Niquel	NT632594
45/50	Niquel	NT632605
40/40 Pomo	Niquel	NT775098
50/50	Niquel	NT349614
40/60	Seguridad	NT640081

4 Cerradero Central

Ver Página 33

5 Cerradero de Gancho

Ver Página 33

6 Bisagra Puerta, PS23 14-17.5/ 85-31 hasta 80 kg

Color	Código
Blanco	NT492520
Marron	NT492519
Plata	NT493275
Negro	NT782925

6 Bisagra Puerta, PS27 14-17.5/ 105-39 hasta 120 kg

Color	Código
Blanco	NT492575
Marron	NT492574
Plata	NT2028262
Negro	NT784711

Cerradura y Contra - cerradura 2 Hojas

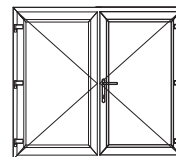

1 Cerradura H650 con prolongación arriba

AG	FFV	G	Código
28 m	1750-3000	1020	NT2003443
35 m	1750-3000	1020	NT2003444

Cerradura H650 con prolongación arriba/abajo

AG	FFV	G	Código
28 mm	1750-3000	1020	NT2003448
35 mm	1750-3000	1020	NT2003449

2 Palancas de rebajo (Cerradura 2° hoja)

Descripción	Código
Solo para cerradura con Prol. Sup. y Pasador Inf.	NT633304
Solo para cerradura con Prol. Sup. e Inf.	NT899172

*Consultar cerraduras en pag. 27

Pasador Inferior

Descripción	Código
Pasador Inf. a cerradura	NT633325

4 Pasador Superior de Contra-Cerradura de Batiente

FFV	Código
1750-2800	NT492135

5 Prolongador de Cerradura 400 x 16

Largo	Código
200	NT633956
400	NT633934

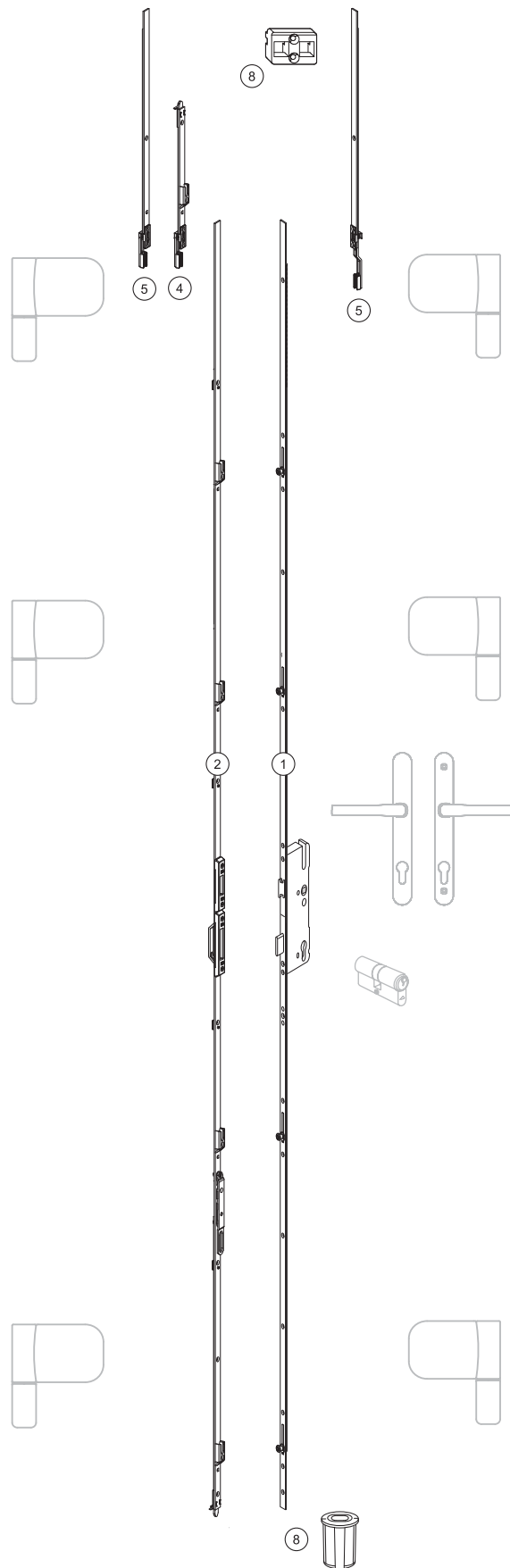
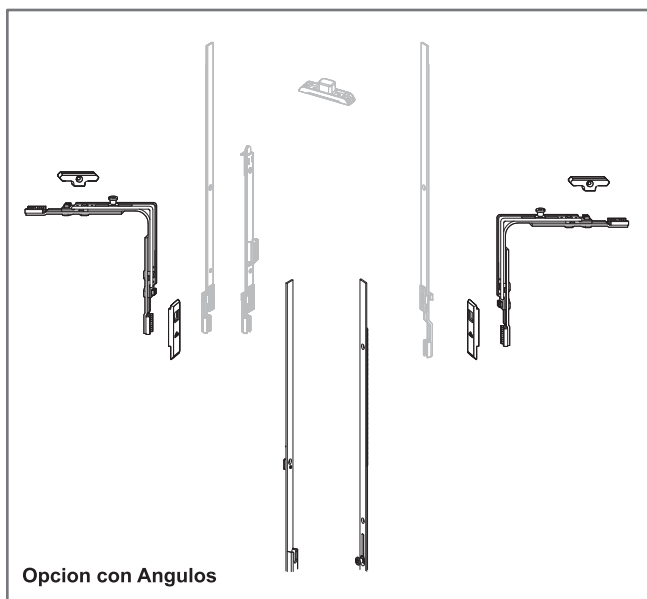

Piezas Opcionales Plantillas Bisagra de Puerta

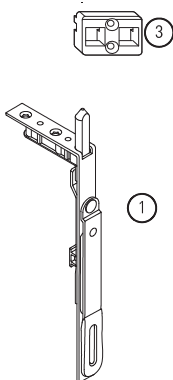
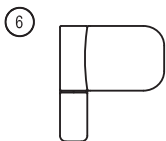
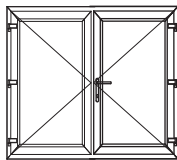

1 Pasador Puerta a Solera 150mm

Código
NT388354

2 Casquillo Embutido Obra

Código
NT225328

3 Cerradero pasador 2 hojas

Ir a la Página 27

6 Bisagra Puerta, PS23 14-17.5 / 85-31 Hasta 80 kg

Color	Código
Blanco	NT492520
Marron	NT492519
Plata	NT493275
Negro	NT782925

6 Bisagra Puerta, PS27 14-17.5 / 105-39 Hasta 120 kg

Color	Código
Blanco	NT492575
Marron	NT492574
Plata	NT2028262
Negro	NT784711

4 Plantilla de ajuste de presion

Código
NT535285

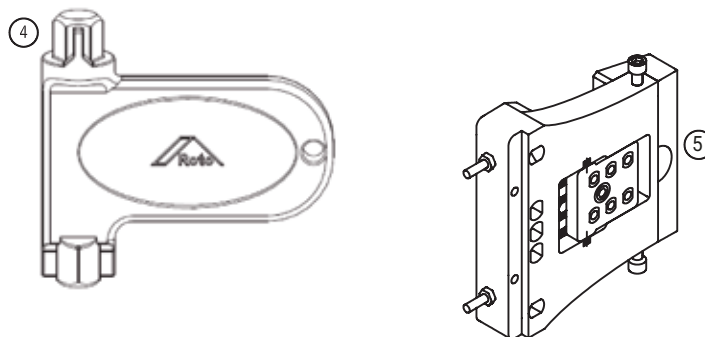

5 Plantillas de Bisagra Puerta

Tipo	Código
PS23	NT447048
PS27	NT447050

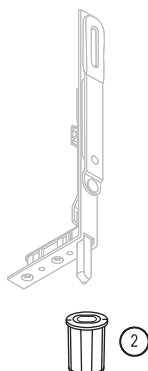
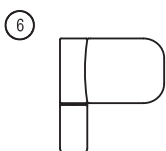
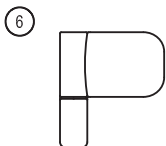

Cerraderos Puerta

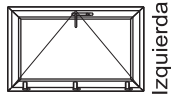

Izquierda

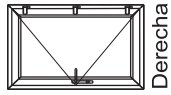

Derecha

Perfil	Ranura/Ala	Medida de cilindro	Cerradero de Bulon	Cerradero Combinado	C. Central Derecho	C. Central Izquierdo	Cilindro	Cerradero P/RECTO	Cerradero GANCHO	Cerradero DOORTEC
Aluplast 2000	13 / 20	40/40	NT331489	NT609862	NT390685	NT390684	NT632590	NT390695	NT349261	NT349272
Aluplast 4000	13 / 20		-	-	NT442056	NT442055		-	NT349290	-
Deceunink Everetmax/Legend	13 / 20		NT370071	-	NT390985	NT390984	NT632594	NT390992	NT382703	NT371707
Kommerling Eurodur	13 / 20	40/40	NT260365	NT609887	NT390766	NT390765	NT632590	NT390772	NT350528	NT350538
Kommerling Eurofutur	13 / 20	45/45	NT334957	NT609887	NT390766	NT390765	NT632594	NT390772	NT349237	NT609887
Kommerling 76	13 / 20		NT738471	-	NT390901	NT390900		NT390904	NT349237	NT609887
Profine eurofine Kbe70	13 / 20		NT738471	-	NT390901	NT390900		NT390904	NT349237	NT609887
Rehau 4500	13 / 20		NT332439	NT609860	NT390660	NT390659	NT632590	NT390670	NT349214	NT349226
Tecnoperfiles Newen/Efficient	13 / 20		NT332438		NT390854	NT390853	NT632590	NT390860	NT355675	N/A
Veka 58	13 / 20		-		NT390854	NT390853	NT349612	-	NT355675	-
Tecnocom	9 / 20		NT260368		NT390808	NT390807	NT349573	NT390814	NT351491	-
Batiente para eje de 9			NT260359		NT390745	NT390744		-		-
Batiente Inversora eje de 13			NT260359		NT442056	NT442055		NT390751	NT349369	

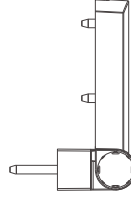
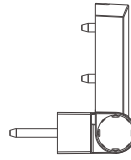

Perfil	Altura de Solape	Medidas para Bisagra PS23	Colores de Bisagra PS23			Colores de Bisagra PS27				
			Blanco 9016	Marron 8077	Plata 1036	Negro 9005	Blanco	Marron	Bruto	Negro
Aluplast 2000	16	14-17.5	NT492520	NT492519	NT492517	NT782925	NT492575	NT492574	NT492573	NT784711
Deceunink Everetmax/Legend		17-20.5	NT492558	NT492556	NT492524	NT2006368	NT492584	NT492582	NT492581	NT782926
Kommerling Eurodur	15	14-17.5	NT492520	NT492519	NT492517	NT782925	NT492575	NT492574	NT492573	NT784711
Kommerling Eurofutur	19	17-20.5	NT492558	NT492556	NT492524	NT2006368	NT492584	NT492582	NT492581	NT782926
Kommerling 76		17-20.5	NT492558	NT492556	NT492524	NT2006368	NT492584	NT492582	NT492581	NT782926
Eurofine 58		17-20.5	NT492558	NT492556	NT492524	NT2006368	NT492584	NT492582	NT492581	NT782926
Eurofine 70		20-23.5	NT492568	NT492567	NT492565	NT824836	NT492596	NT492594	NT492592	NT782926+Calizo
Rehau 4500		14-17.5	NT492520	NT492519	NT492517	NT782925	NT492575	NT492574	NT492573	NT784711
Tecnoperfiles Newen/Efficient		14-17.5	NT492520	NT492519	NT492517	NT782925	NT492575	NT492574	NT492573	NT784711

Corrediza Inline Ventana

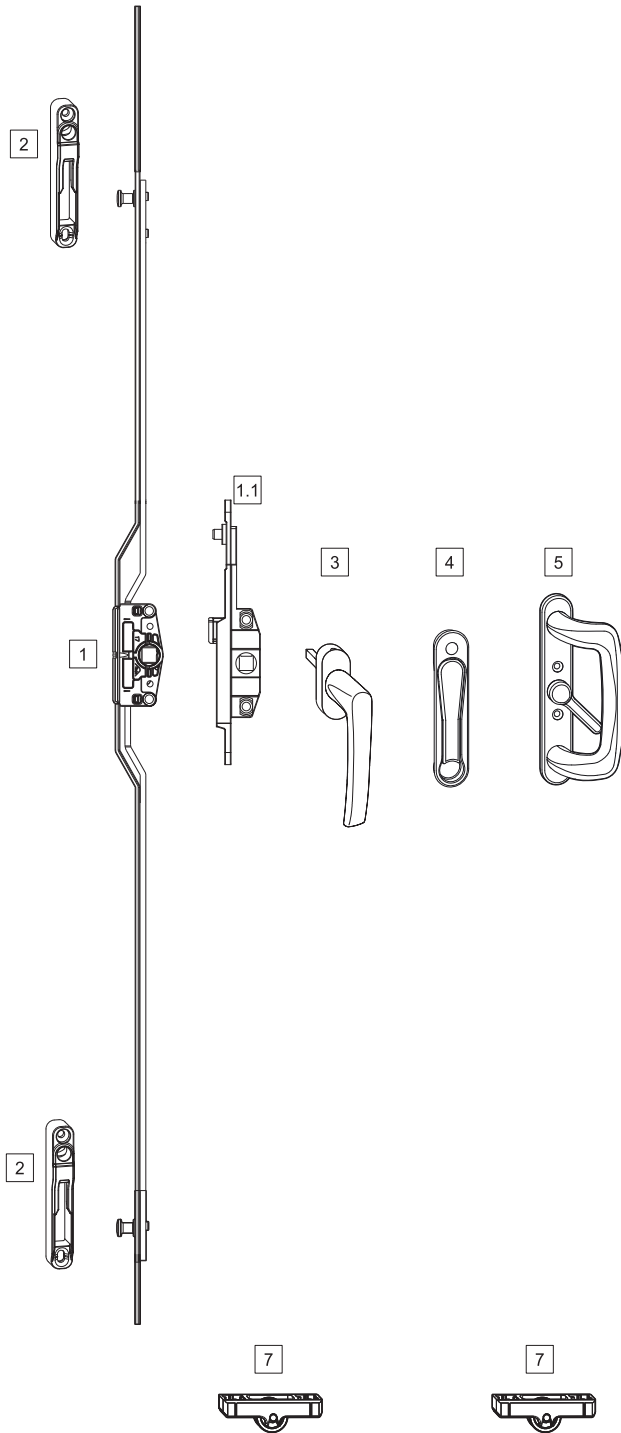
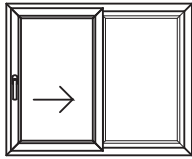

1 Cremona Corrediza Aguja de 7mm NX INLINE

FFH	#B	Longitud	Código
401-600	2	400	NT628429
601-800	2	600	NT628430
801-1000	2	800	NT628431
1001-1200	3	1000	NT628432
1201-1800	3	1200	NT628433
1801-2400	4	1800	NT628434

1.1 Cremona Corrediza Aguja de 10mm NLINE

FFH	#B	Longitud	Código
140-1200	1	140	NT765437

2 Cerraderos INLINE SLIDING

FFH	Cantidad	Código
400-1000	2	Ver Página 39
1001-1800	3	Ver Página 39
1801-2400	4	Ver Página 39

3 Manilla ROTO LINE

Color	Código
Blanco	NT2033352
Marron	NT256230
Titan	NT255369
Bronce	NT348329
Negro	NT794254

4 Manilla POP-UP

Color	Código
Blanco	NT312766
Marron	NT323277
INOX	NT323280
Negro	NT493898

5 Manilla Tirador Interior Inline Sliding

Color	Código
Blanco	NT613226
Marron	NT613224
Plata	NT613222
Negro	NT613225

*Con el uso de la Manilla tirador incluir 1

Aluplast	NT2000141
Rehau / Kommerling	NT2000147
Salamander	NT2000142

7 Ruedas hasta 50 Kg

Altura de la Rueda	Código
17 mm	NT637616
21mm	NT637617

Corrediza Inline Puerta

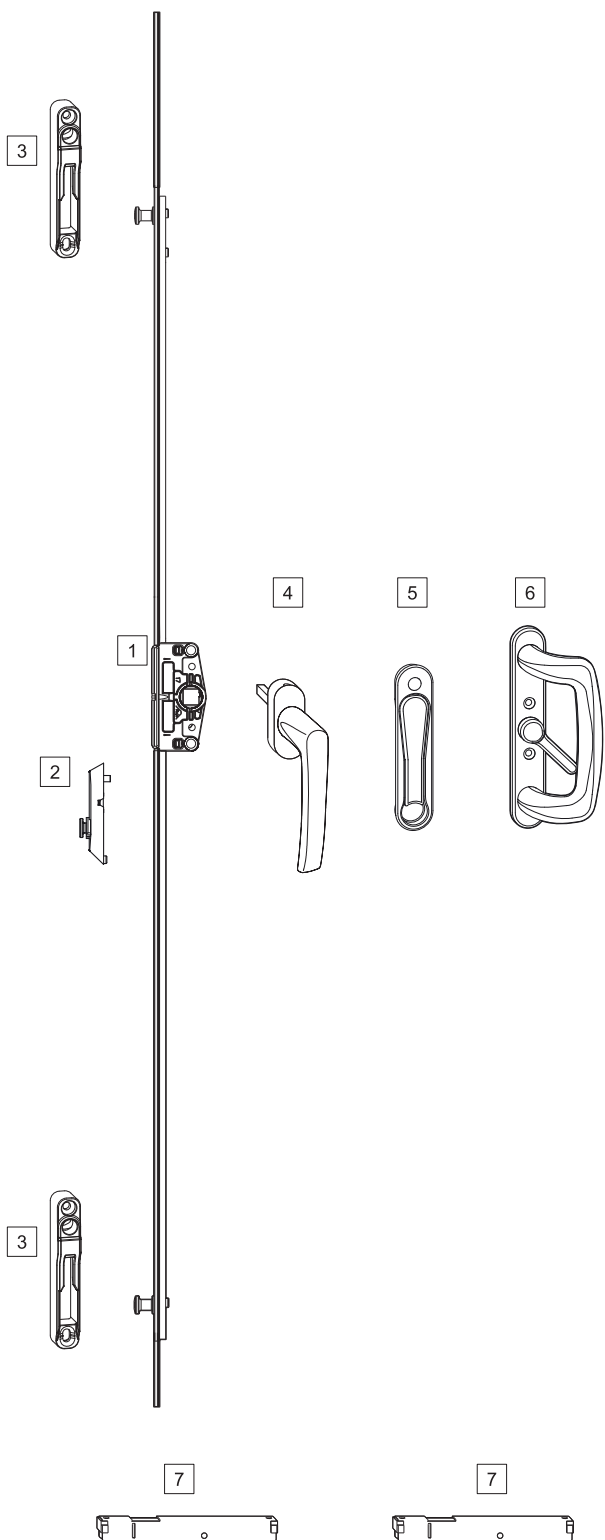
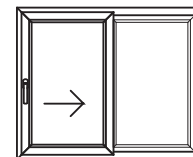

1 Cremona Corrediza Aguja de 17mm NX

FFH	#B	Longitud	Código
200-400	2	240	NT628482
401-600	2	400	NT628483
601-800	2	600	NT628484
801-1000	2	800	NT628495
1001-1200	3	1000	NT628496
1201-1800	3	1200	NT628497
1801-2400	4	1800	NT628498

2 Mecanismo de falsa maniobra multipunto

FFH	Código
>800	NT343733

3 Cerraderos INLINE SLIDING

FFH	Cantidad	Código
240-1000	2	Ver Página 39
1001-1800	3	Ver Página 39
1801-2400	4	Ver Página 39

4 Manilla ROTO LINE

Color	Código
Blanco	NT2033352
Marron	NT256230
Titan	NT255369
Bronce	NT348329
Negro	NT794254

5 Manilla POP-UP

Color	Código
Blanco	NT312766
Marron	NT323277
INOX	NT323280
Negro	NT493898

6 Manilla Tirador Interior INLINE SLIDING

Color	Código
Blanco	NT613226
Marron	NT613224
Plata	NT613222
Negro	NT613225

*Con el uso de la Manilla tirador incluir 1

Aluplast	NT2000141
Rehau / Kommerling	NT2000147
Salamander	NT2000142

7 Ruedas hasta 100 Kg

Altura de la Rueda	Ancho	Código
19-26 mm	12 mm	NT615951
19-26 mm	14 mm	NT622876

Corrediza Inline con Llave

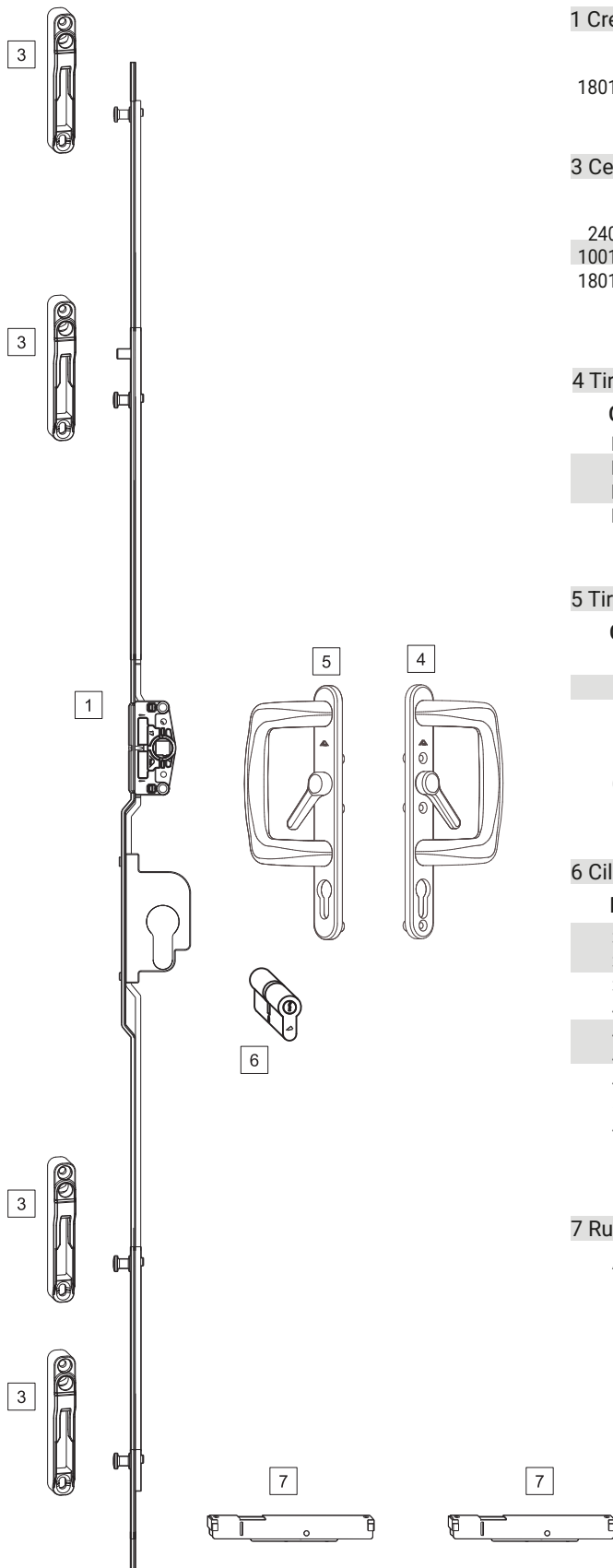
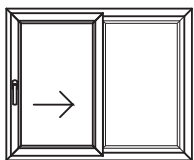

1 Cremona Corrediza con Llave Aguja de 17mm

FFH	B	Largo	Código
1801-2400	4	1800	NT628499

3 Cerraderos INLINE SLIDING

FFH	Cantidad	Código
240-1000	2	Ver Página 39
1001-1800	3	Ver Página 39
1801-2400	4	Ver Página 39

4 Tirador INLINE INTERIOR C/cilindro

Color	Código
Blanco	NT613243
Marron	NT613241
Negro	NT613242
Plata	NT613239

5 Tirador INLINE EXTERIOR C / Cilindro

Color	Código
Blanco	NT613217
Marron	NT613215
Negro	NT613216
Plata	NT613203

Con el uso de los Tiradores se requiere 1pz de NT613179

6 Cilindro

Medida	Medida	Código
31/31	Niquel	NT349514
35/35	Niquel	NT349572
35/45	Niquel	NT349574
40/40	Niquel	NT632590
45/45	Niquel	NT632594
45/50	Niquel	NT6326 5
40/40 Pomo	Niquel	NT775098
50/50	Niquel	NT349614
40/60	Seguridad	NT640081

Llave Virgen NT349755

7 Ruedas hasta 100 Kg

Altura de la Rueda	Ancho	Código
19-26 mm	12 mm	NT615951
19-26 mm	14 mm	NT622876

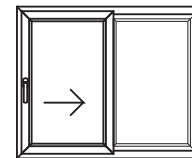

1



2

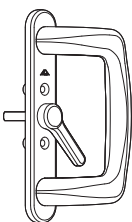

3

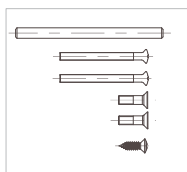

1 Tirador uñero exterior INLINE

Color	Código
Blanco	NT605543
Marron	NT613185
Plata	NT613183
Negro	NT605551

2 Tirador interior INLINE

Color	Código
Blanco	NT613226
Marron	NT613224
Plata	NT613222
Negro	NT613225

3 Bolsa de tornillos Typ 1 NT613170

4

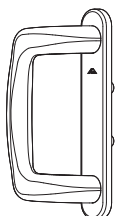

5



6

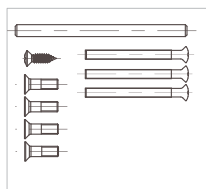

4 Tirador exterior INLINE

Color	Código
Blanco	NT613191
Marron	NT613189
Negro	NT613190
Plata	NT613187

5 Tirador interior con cilindro INLINE

Color	Código
Blanco	NT613243
Marron	NT613241
Negro	NT613242
Plata	NT613239

3 Bolsa de tornillos Typ 2

Serie	Código
Aluplast	NT2000141
Rehau / Kommerling	NT2000147
Salamander	NT2000142

Tirador para corredera Inline

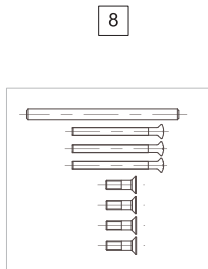
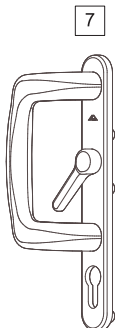
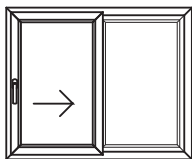

5 Tirador interior con cilindro INLINE

Color	Código
Blanco	NT613243
Marron	NT613241
Negro	NT613242
Plata	NT613239

7 Tirador exterior con cilindro INLINE

Color	Código
Blanco	NT613217
Marron	NT613215
Negro	NT613216
Plata	NT613203

8 Bolsa de tornillos Typ 1

NT613179

9

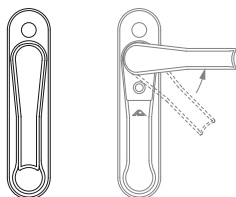

10

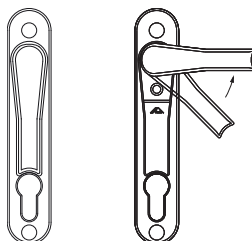

9 Manilla POP-UP / Oculta Sencilla

Color	Código
Blanco ral 9016	NT312766
Marron	NT323277
Inox	NT323280
Negro	NT493898

10 Manilla POP-UP / Oculta con Cilindro

Color	Código
Blanco	NT323282
Marron	NT323283
Inox	NT323287

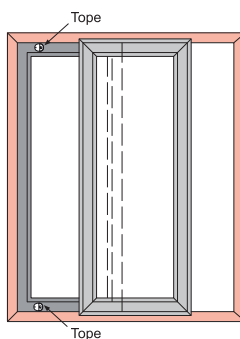
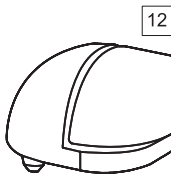

12 Tope Retenedor

Color	Código
Blanco	NT317250
Marron	NT317251
Negro	NT335555

sin LACAR	NT317249
Tope goma (negro) para reposición	NT317252

Definición de apertura según DIN

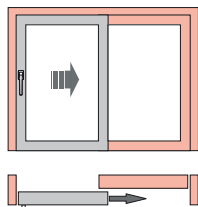
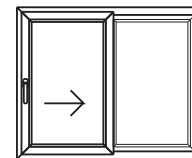

Izquierda

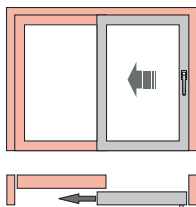

Derecha



Perfil - Serie	Aguja de Cremona	Cerraderos		Rueda 50 Kg	Rueda 120 Kg	Rueda 200 Kg
		Derecho	Izquierdo			
Aluplast Serie 60 ventana	7	NT629559		NT637616	-	-
Aluplast Serie 80/96 puerta	17	NT629559		-	NT615951	NT603430
Deceunink Zendow	17	NT483605		NT637617	NT615951	NT603430
Kommerling SF2/ Premiline ventana 58	7	NT629555	NT629554	NT637617	-	-
Kommerling SF2/ Premiline puerta 80	17	NT629555	NT629554	-	NT615951	NT603430
Kommerling SF3	7	NT629551		NT637617	-	-
Rehau S920 Hoja 1 Ventana	7	NT629551		NT637616	-	-
Rehau S920 Hoja 2 Puerta	17	NT629551		-	NT615951	NT603430
Rehau S920 Hoja 86 Puerta	17	NT629551		-	NT615951	NT603430
Tecnocom 1010 Puerta	17	NT629560		-	NT615951	NT603430
Tecnocom 1011 / 1012 Ventana	7	NT629560		NT637617	-	-
Veka Softline CR73 Hoja 70	7	NT629560		NT637617	-	-
Veka Softline CR73 Hoja 82	17	NT629560		-	NT615951	NT603430
Rehau (Cerradero sintético)	7/17	NT771377				

Aperturas Especiales

Ventana Plegable

Listado de herraje

Esquema 431

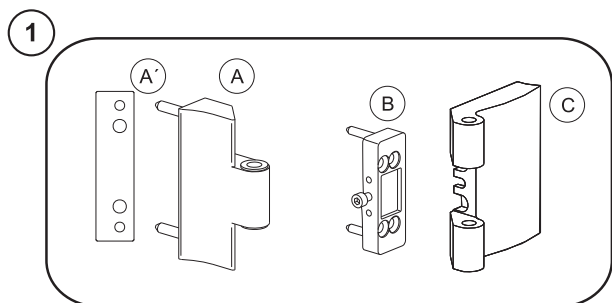
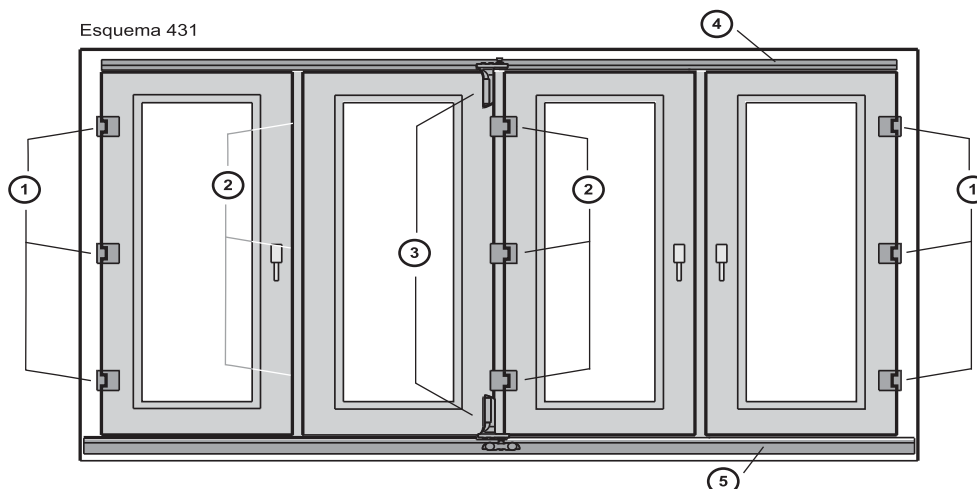

A Bisagras de Marco (3pzs por código)

Color	Galce de hoja	Código
Blanco	16mm	NT733375
Marron	16mm	NT738911
Plata	16mm	NT733377
Negro	16mm	NT768759
Blanco	21mm	NT733383
Marron	21mm	NT738906
Plata	21mm	NT733485
Negro	21mm	NT768761

A' Calzo Bisagra a Marco (3pzs por código)

Color	Medida	Código
Blanco	1mm	NT312831
Marron	1mm	NT490461
Blanco	2mm	NT312834
Marron	2mm	NT490460

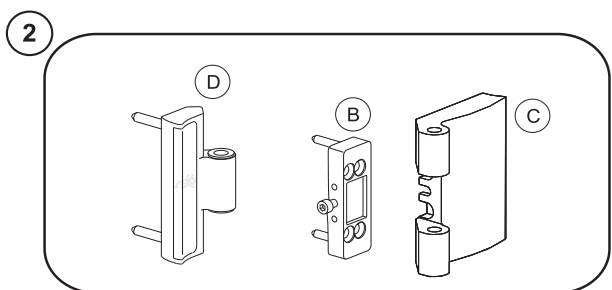

B Bases de Bisagras (3 pzs por código)

Código
NT733491

C Bisagras de hoja *LARGA (3 pzs por código)

Color	Medida	Código
Blanco	50	NT733369
Marron	50	NT738905
Plata	50	NT733371
Negro	50	NT768758

D Bisagras soportes de hoja *CORTA (3 pzs por código)

Color	Medida	Código
Blanco	20	NT734361
Marron	20	NT738915
Plata	20	NT734363
Negro	20	NT768885
Blanco	30	NT734365
Plata	30	NT734374
Negro	30	NT768887

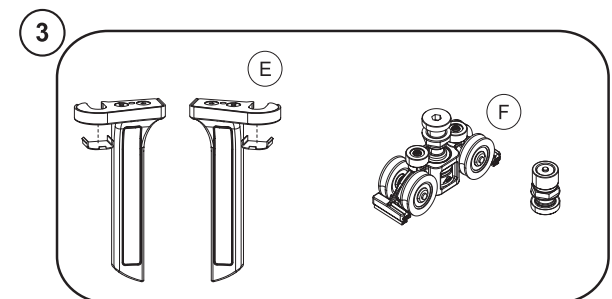

E Soportes de carros (1 par por código)

Color	Código
Blanco	NT642423
Marron	NT738980
Plata	NT642435
Negro	NT768891

F Juego de Carros/Patines

Código
NT642422

Ventana Plegable

Sistema 6100

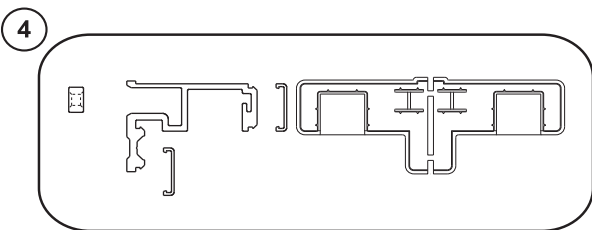

4 Riel Guía Superior

Color	3 Metros	4 Metros	6 Metros
Blanco	NT312797	NT312798	NT312800
Marron	NT490442	NT490441	NT490440
Plata	NT312807	NT312808	NT312810
Negro	NT768900	NT768901	NT768903

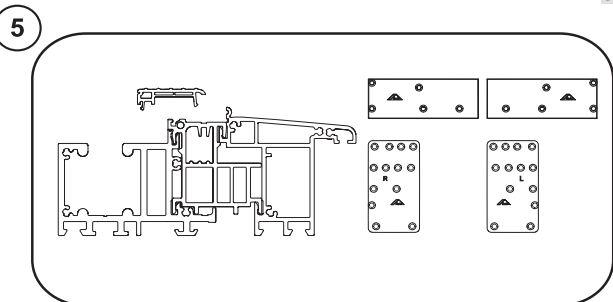

5 Riel Guía Empotrada "Confort" ***requiere accesorios

Color	3 Metros	4 Metros	6 Metros
Plata	NT642448	NT642449	NT642451

*Con el uso de guía empotrada, se requiere utilizar para los bulones inferiores el cerradero de basculacion 6100. Ver Página 43

Accesorios *

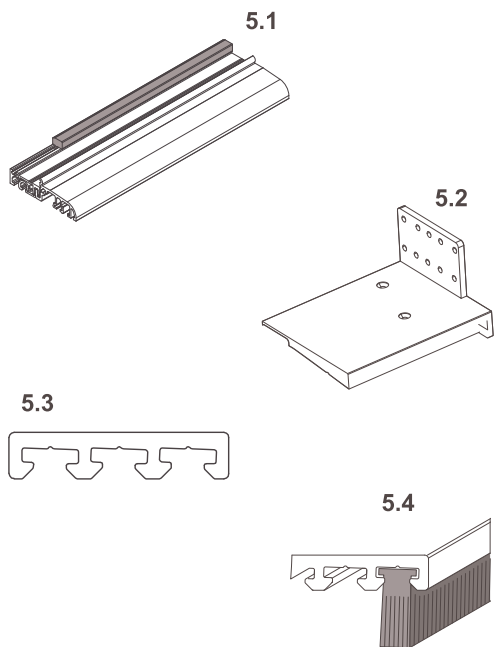

5.1 Adaptador para perfil Solera Confort / Eifel

Color	6 Metros
Gris	NT548528

*Se utilizan 2 por sistema

5.2 Par de fijación universal para guía Confort

Color	6 Metros
Gris	NT571778

5.3 Perfil inferior para sujetar felpa - triple carril

Color	Largo	Código
Plata	6 metros	NT640408

5.4 Felpa fina para sello inferior

Medida	Color	Código
Felpa 10 mm	Gris	NT601080
Felpa 17 mm	Gris	NT604872

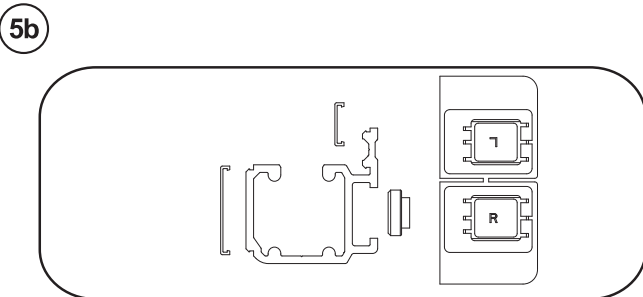

5B Riel Guía Marco Cerrado

Color	3 Metros	4 Metros	6 Metros
Blanco	NT642436	NT642437	NT642439
Marron	NT738945	NT738955	NT738956
Plata	NT642444	NT642445	NT642447
Negro	NT768896	NT768897	NT768899

Ventana Plegable

Sistema 6100

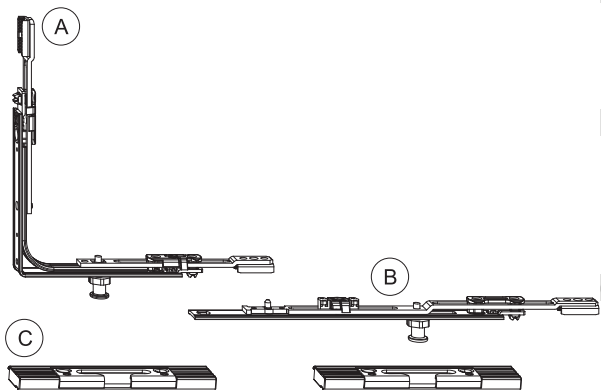

A Angulo de cambio para 6100

Código
NT614456

B Cierre Central para 6100

Longitud

400 mm
600 mm

Código
NT566651
NT618553

C Cerradero de Basculación Komfort 6100 Eifel

Eje

13 mm
9 mm

Código
NT2001883
NT496779

Complementos

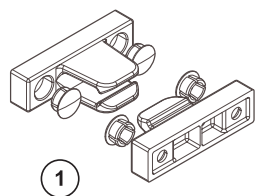

1 Clip retenedor de hoja libre

Color

Blanco
Marron
Plata
Negro

Código
NT340208
NT340211
NT375241
NT340211

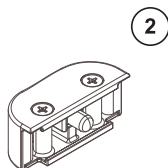

2 Tope de hoja

Color

Blanco
Marron
Plata
Negro

Código
NT444807
NT444808
NT444809
NT768940



3 Tapa de Recubrimiento en guías para hoja de paso

Color

Plata

Código
NT642452

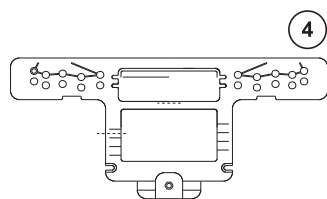

4 Plantilla para carros y bisagras

Código
NT643365

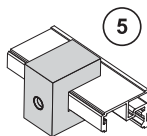

5 Plantilla para colocación de tope de hoja

Código
NT469831

Descarga ahora los
Planos de sistema



Ventana Plegable Sistema 6100

Esquemas

330

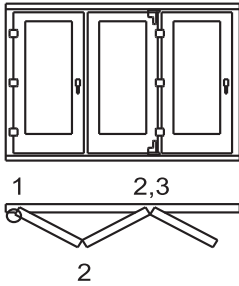

321

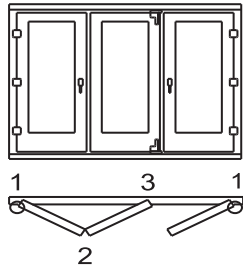

431

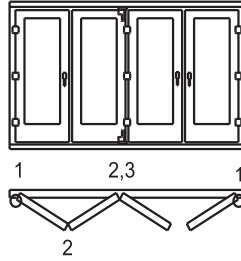

532

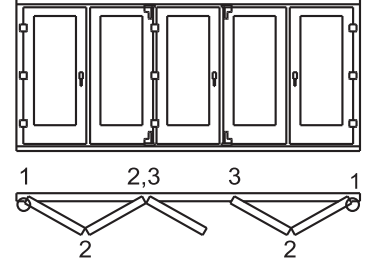

541

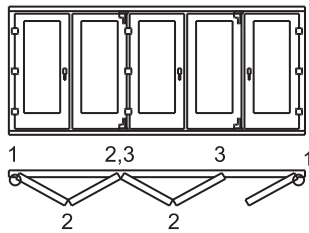

Esquema 532

Número hojas total

Número de las hojas
que abren hacia la
izquierda o derecha

Número hojas que
abren hacia la
derecha o izquierda

550

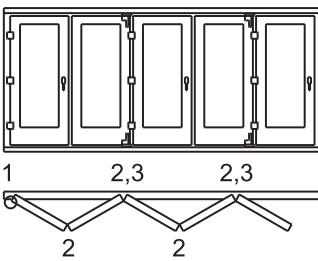

633

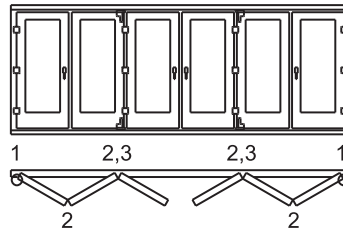

651

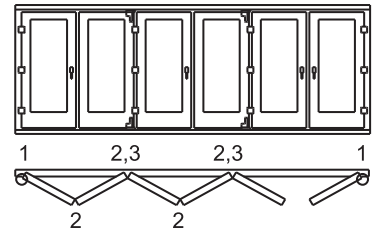

743

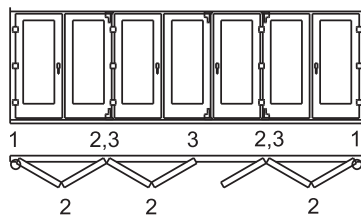

761

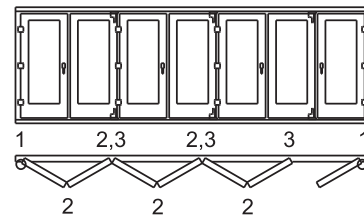

770

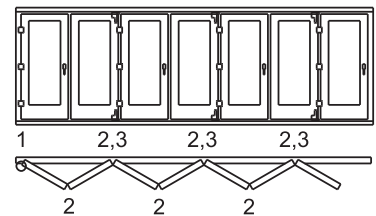

Ventana Elevable Sistema PATIO LIFT

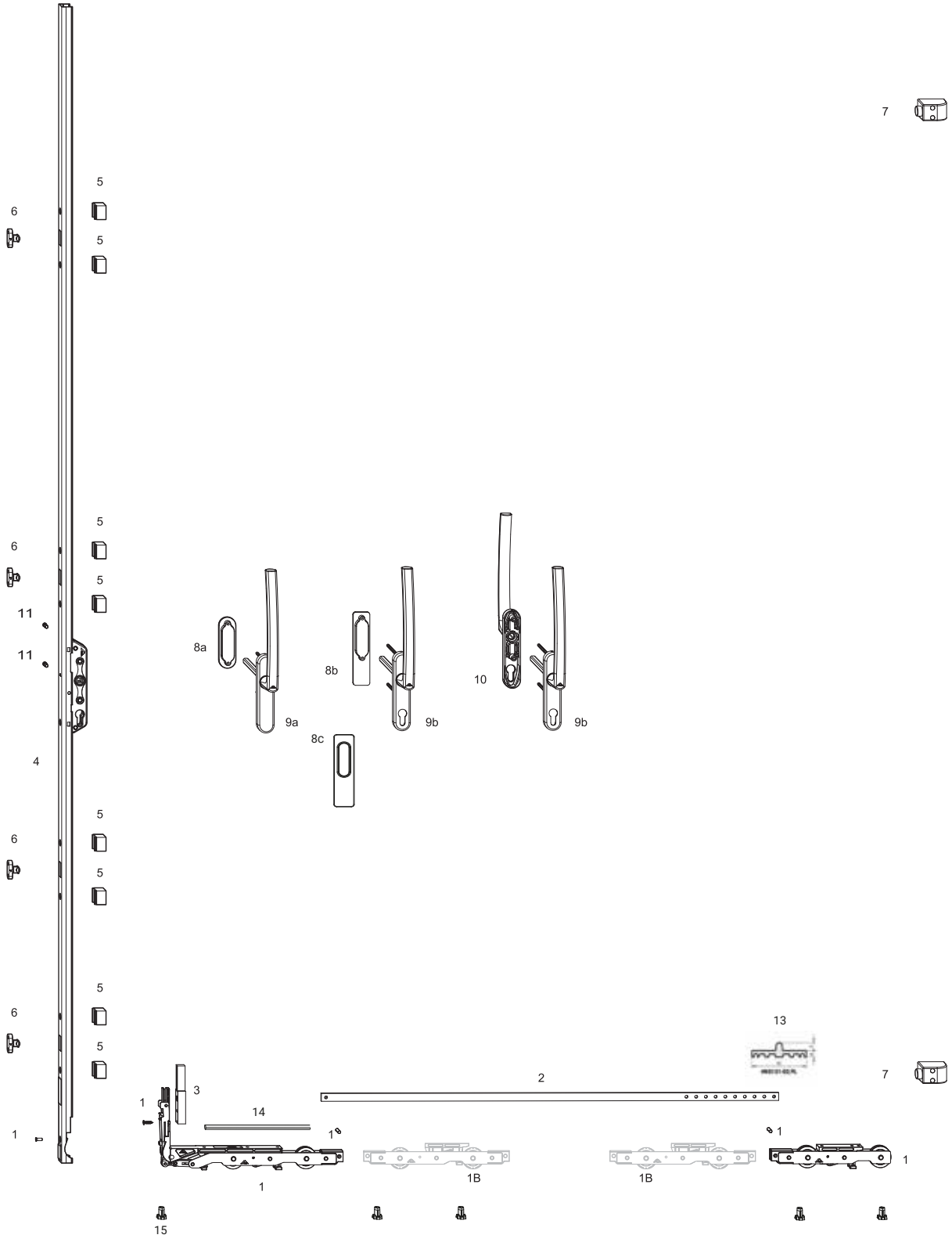

Ventana Elevable

Sistema PATIO LIFT



1 Carton básico Patio LIFT Hasta 300 Kg

Peso	Código
300 Kg	NT899520

1B Carro adicional Patio LIFT Hasta <400 Kg

Peso	Código
400 Kg	NT626567
*Incluir 2 pzs por hoja	

2 Barra de conexión Patio LIFT

Medida	Rango SW	Código
895 mm	720-1600	NT634852
1200 mm	1601-1900	NT595649
1500 mm	1901-2200	NT634853
1800 mm	2201-2500	NT606712
2300 mm	2501-3000	NT634854

3 Calzo para CARRO Patio LIFT

Medida	Perfil	Código
30 mm	Rehau	NT840779
30 mm	Salamander	NT840779
25 mm	Veka	NT840778
25 mm	Kommerling	NT840778

4 Cremona Patio LIFT

	Rango SH	Código
Esta cremona no tiene opción para cilindro	1000-1800	NT840816
	1801-2200	NT840378
	2201-2600	NT2001803
	2601-3000	NT840382

5 Calzo para CREMONA Patio LIFT (Juego de 8 piezas)

Medida	Perfil	Código
30 mm	Aluplast	NT606766
30 mm	Rehau	NT606766
25 mm	Veka 70 mm	NT636526

6 Cerradero para CREMONA Patio LIFT (Juego de 8 piezas)

Medida	Perfil	Esquema	Código
17 mm	Aluplast	A, D	NT635128
30 mm	Rehau	C	NT739039
30 mm	Rehau		NT639864
17 mm	Veka 70 mm		NT635158

7 Tope de hoja PATIO LIFT

Medida	Código
27 mm	NT2006306

8a Uñero OVAL de manilla Patio LIFT

Color	Código
Blanco	NT635159
Negro	NT635160
Plata	NT635161
sin lacado	NT635163

8b Uñero RECTANGULAR de manilla Patio LIFT 7

Color	Código
Blanco	NT635149
Negro	NT635150
Plata	NT635151
sin lacado	NT635153

8c Uñero CUADRADO 11 mm de profundidad

Color	Código
Blanco	NT635154
Negro	NT635155
Plata	NT635156

Kit de tornillos

Aluplast	NT2000141
Rehau	NT2000147
Kommerling	NT2000147
Salamander	NT2000142

*En caso de no agregar kit de atornillamiento 2 por hoja

Guiadores	
Aluplast	NT899512
Rehau	N/A
Kommerling	N/A
Salamander	NT899512

9a Manilla Sencilla interior Patio LIFT

Color	Código
Blanco	NT635144
Negro	NT635145
Plata	NT635146
sin lacado	NT635148

9b Manilla para cilindro interior Patio LIFT 150

Color	Código
Blanco	NT635129
Negro	NT635130
Plata	NT635131
sin lacado	NT635133

10 Manilla para cilindro exterior Patio LIFT 150

Color	Código
Blanco	NT635134
Negro	NT635135
Plata	NT635136
sin lacado	NT635138

11 Insertos para manilla sin uso de uñeros

Código
NT635152

13 Riel para elevadora HS

Descripción	Código
Riel para elevadora 6700 mm (Siegenia)	NT129517

14 Varilla redonda LIFT

Medida	Código
1591 - 2190	NT2000126
2191 - 3000	NT2000127
Incluir tornillos para sujeción	NT899526

15 Pieza de apoyo carros PATIO LIFT

Peso	Cantidad	Código
300 KG	3	NT762901
400 KG	5	NT762901

Ventana Osciloparalela

Sistema PATIO ALVERSA

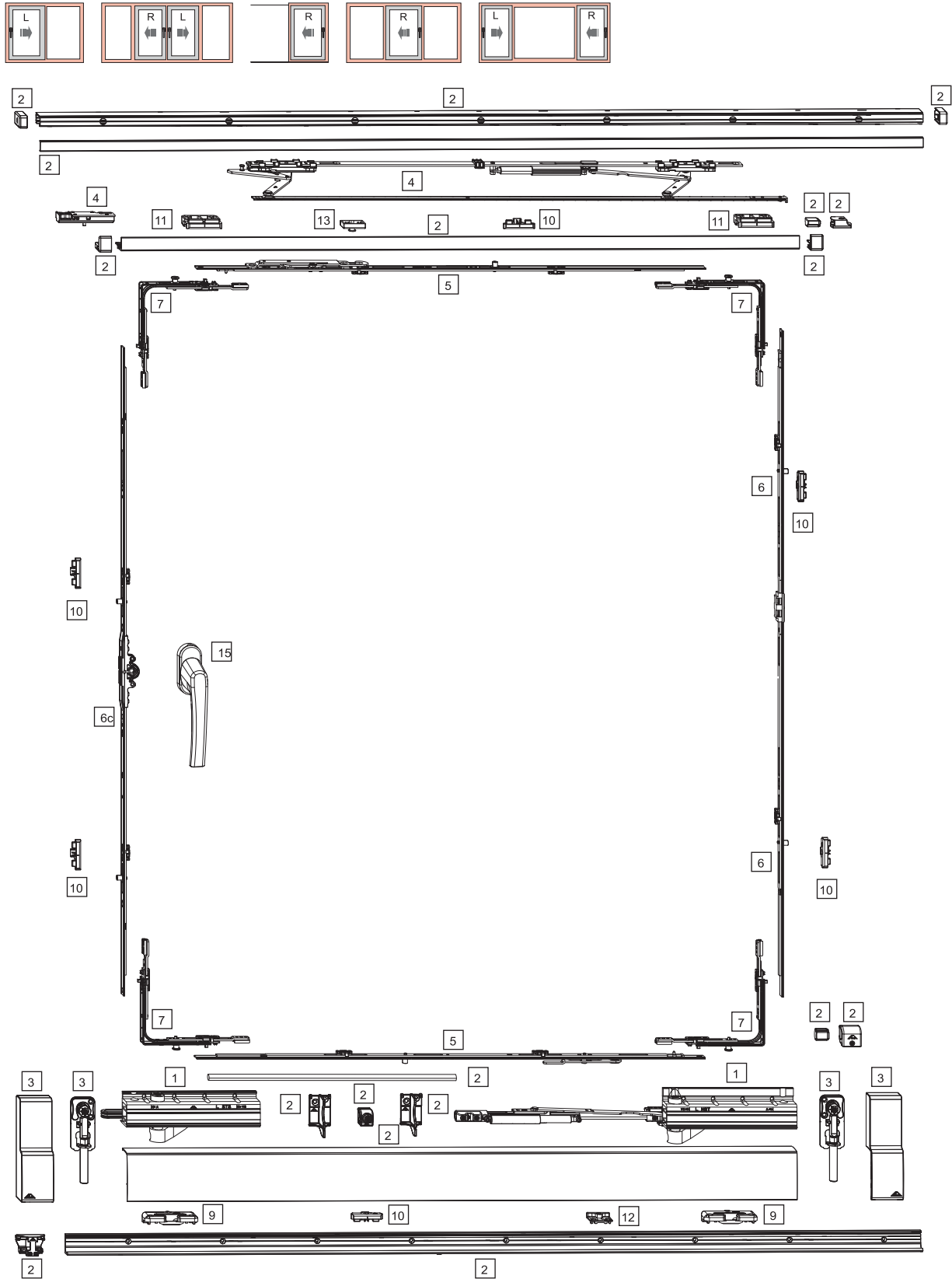

Ventana Osciloparalela

Sistema PATIO ALVERSA



1 Carton Base Hasta 200 Kg

Peso	Mano	Código
160 Kg	Derecha	NT799833
160 Kg	Izquierda	NT799832
200 Kg	Derecha	NT799895
200 Kg	Izquierda	NT799804

2 Juego de Rieles (con accesorios)

Medida	Rango FFB	Color	Código
2630 mm	600-1250	Blanco	NT766794
4130 mm	1251-2000	Blanco	NT769807
2630 mm	600-1250	Marron	NT766789
4130 mm	1251-2000	Marron	NT769775
2630 mm	600-1250	Negro	NT780476
4130 mm	1251-2000	Negro	NT780479

3 Set soporte para Refuerzo con embellecedor >100 Kg

Color	Código
Blanco	NT793513
Marron	NT793510
Negro	NT793512
Plata	NT793508

4 Compas deslizante + pieza guia

Mano	Rango FFB	Código
Derecha	750-900	NT808827
Derecha	901-1250	NT808828
Derecha	1251-1650	NT808829
Derecha	1651-2000	NT808830
Izquierda	750-900	NT808816
Izquierda	901-1250	NT808824
Izquierda	1251-1650	NT808825
Izquierda	1651-2000	NT808826

5 Varilla Horizontal (superior e inferior)

Mano	Rango FFB	Código
Derecha	750-1000	NT776915+1 pza*
Derecha	1001-1200	NT776917+1 pza*
Derecha	1201-1400	NT776919+2 pza*
Derecha	1401-2000	NT776921+2 pza*
Derecha	1651-1850	2X+NT337710
Derecha	1851-2000	2X+NT337711
Izquierda	750-1000	NT776884+1 pza*
Izquierda	1001-1200	NT776916+1 pza*
Izquierda	1201-1400	NT776918+2 pza*
Izquierda	1401-2000	NT776920+2 pza*
Izquierda	1651-1850	2X+NT337710
Izquierda	1851-2000	2X+NT337711

6 Prolongacion Vertical

B	Rango FFB	Código
1	650-800	NT788318
1	801-1200	NT788320
2	1201-1600	NT788322
2	1601-2000	NT795365
4	2001-2400	NT795367

6c Cremona de cota Variable aguja 15 mm

B	Rango FFB	Código
1	621-800	NT355743
1	801-1200	NT355744
2	1201-1600	NT355745
2	1601-2000	NT795390
4	2001-2400	NT795393

7 Angulos de Cambio

Código
NT260272

9 Cerradero de Basculacion

Ver Pag. 27

10 Cerraderos

Ver Pag. 27

11 Cerraderos de Seguridad

Ver Pag. 27

12 Falsa maniobra Alversa

Perfil	Código
Aluplast 2000	NT785931
Aluplast 4000	NT785937
Veka 58	NT785931
Deceuninck	NT785931
Rehau 4500	NT785937
Schuco	NT785937
Kommerling Eurofutur	NT785936
Kommerling 76	NT785934
Profine Eurofine kbe70	NT785934
Tecnoperfiles Newen/ Efficient	NT785931

Soporte Marco

Perfil	Código
Aluplast 2000	NT776291
Aluplast 4000	NT776292
Kommerling Eurofutur	NT776288
Kommerling 76	NT776297
Profine Eurofine kbe70	NT776297
Rehau 4500	NT776307
Tecnoperfiles Newen/ Efficient	NT776293
Deceuninck Everestmax/legend	NT776308
Veka 58	NT776293

15 Manilla Patio S

Color	Cuadradillo	Código
Blanco	35 mm	NT211596
Marron	35 mm	NT288727
Blanco	40 mm	NT601166
Marron	40 mm	NT601165
Negro	35 mm	NT794352

Ventana Paralela Sistema PATIO ALVERSA

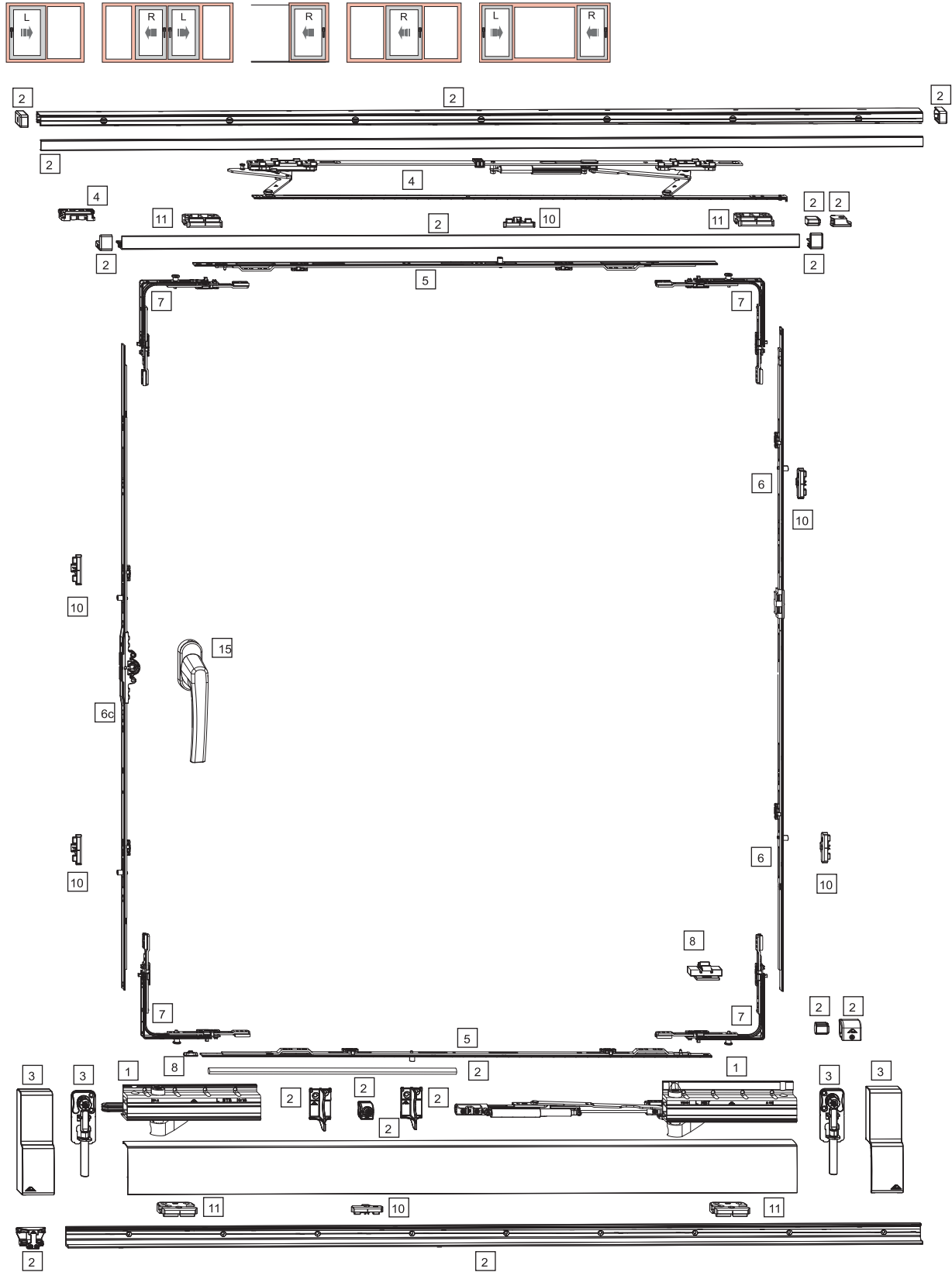

Ventana Paralela

Sistema PATIO ALVERSA



1 Carton Base Hasta 200 Kg

Peso	Mano	Código
160 Kg	Derecha	NT799833
160 Kg	Izquierda	NT799832
200 Kg	Derecha	NT799895
200 Kg	Izquierda	NT799804

2 Juego de Rieles (con accesorios)

Medida	Rango FFB	Color	Código
2630 mm	600-1250	Blanco	NT766794
4130 mm	1251-2000	Blanco	NT769807
2630 mm	600-1250	Marron	NT766789
4130 mm	1251-2000	Marron	NT769775
2630 mm	600-1250	Negro	NT780476
4130 mm	1251-2000	Negro	NT780479

3 Set soporte para Refuerzo con embellecedor >100 Kg

Color	Código
Blanco	NT793513
Marron	NT793510
Negro	NT793512
Plata	NT793508

4 Compas deslizante + pieza guia

Mano	Rango FFB	Código
Derecha	750-900	NT772225
Derecha	901-1250	NT772226
Derecha	1251-1650	NT772227
Derecha	1651-2000	NT772228
Izquierda	750-900	NT772220
Izquierda	901-1250	NT772221
Izquierda	1251-1650	NT772222
Izquierda	1651-2000	NT772223

5 Varilla Horizontal (superior e inferior)

Rango FFB	Código
600-800	NT603442
801-1000	NT603444
1001-1200	NT603447
1201-1400	NT603462
1401-2000	NT603466
1651-1850	2X+NT337710
1851-2000	2X+NT337711

6 Prolongación Vertical

B	Rango FFH	Código
1	650-800	NT788318
1	801-1200	NT788320
2	1201-1600	NT788322
2	1601-2000	NT795365
4	2001-2400	NT795367

6c Cremona de cota Variable aguja 15 mm

B	Rango FFH	Código
1	621-800	NT355743
1	801-1200	NT355744
2	1201-1600	NT355745
2	1601-2000	NT795390
4	2001-2400	NT795393

7 Angulos de Cambio

Código
NT260272

8 Limitador de Carrera

Código
NT565965

10 Cerraderos

Ver Pag. 27

11 Cerraderos de Seguridad

Ver Pag. 27

12 Falsa maniobra Alversa

Perfil	Código
Aluplast 2000	NT785931
Aluplast 4000	NT785937
Veka 58	NT785931
Deceuninck	NT785931
Rehau 4500	NT785937
Schuco	NT785937
Kommerling Eurofutur	NT785936
Kommerling 76	NT785934
Profine Eurofine kbe70	NT785934
Tecnoperfiles Newen/ Efficent	NT785931

Alversa sujetador

Perfil	Código
Aluplast 2000	NT776291
Aluplast 4000	NT776292
Kommerling Eurofutur	NT776288
Kommerling 76	NT776297
Profine Eurofine kbe70	NT776297
Rehau 4500	NT776307
Tecnoperfiles Newen/ Efficent	NT776293
Deceuninck Everestmax/legend	NT776308
Veka 58	NT776293

15 Manilla Patio S

Color	Cuadradillo	Código
Blanco	35 mm	NT211596
Marron	35 mm	NT288727
Blanco	40 mm	NT601166
Marron	40 mm	NT601165
Negro	35 mm	NT794352

Roto Frank México

Tecnología para ventanas y puertas

Vía Atlixcayotl 5504, Piso 2 Local 201
Reserva Territorial Atlixcayotl,
C.P. 72193 Puebla, Puebla, México

Oficina +52 222 129 2300
Almacén +52 222 129 2301

Info@rotomexico.com
www.rotomexico.com



Tenemos solución para todos los desafíos:

Roto Tilt&Turn | El sistema de herraje oscilo-batiente para ventanas y balconeras

Roto Sliding | El sistema de herraje para grandes aperturas correderas

Roto Door | El sistema de herraje y accesorios para puertas de entrada

Roto Equipment | Tecnología complementaria para ventanas y puertas